

# NEON LAMP TELEPHONY!

*All-Wave T-R-F Receiver!*

**AUG.  
29  
1931**

# RADIO

REG. U.S. PAT. OFF.

# WORLD

The First and Only National Radio Weekly

*492d Consecutive Issue—TENTH YEAR*

Price  
**15 Cents**  
Per Copy

## COMPLETE AC SET A MERE HANDFUL!



A Three Tube Pentode Midget Was Built Into a Cabinet That Formerly Housed Only a Speaker. See pages 6 and 7.

**NEW!** for AUTO Radio  
Types to Fit All Makes of Cars  
**LYNCH**   
Spark Plug and Distributor Suppressors  
Metallized principle insures dependability and long life.  
Write for illustrated catalog WS.  
LYNCH MFG. CO., Inc., 1775 Broadway, N. Y. C.

**METALLIZED RESISTORS**  
**PLAIN ENDS**  
1.0 meg. and 2.0 meg.  
**PIGTAIL ENDS**  
.02 meg. (20,000 ohms) .5 meg. (500,000 ohms)  
.05 meg. (50,000 ohms) 0.1 meg. (100,000 ohms)  
2.0 meg. and 5.0 meg.  
Price, 25c each, all sizes as above.  
Mounting for plain end leaks, Lynch moulded product, 15c.

**DIRECT RADIO CO.**  
143 West 45th St., New York, N. Y.

"RADIO TROUBLE SHOOTING," E. R. Haan. 328 pages, 300 illustrations, \$3. Guaranty Radio Goods Co., 143 W. 45th St., New York.

PHONOGRAPH PICK-UP—Made by Allen-Hough, \$3.32. Guaranty Radio Goods Co., 143 W. 45th St.

**3 TUBE PENTODE**  
A novel 3-tube Pentode circuit with rectifier is described in this issue of Radio World. This circuit makes it possible to have a full fledged midjet receiver at low cost. The receiver is so designed to fit into a Peerless Speaker cabinet.  
**EVERYTHING AT LOWEST PRICES**  
For lowest Wholesale prices on transformers, parts, and cabinet used in this circuit, write for our latest catalog or visit our showroom at once. You can't beat Wholesale Radio for low prices and reliability.  
**WHOLESALE RADIO SERVICE CO.**  
38 Vesey St. New York, N. Y.

**— SPECIALS —**  
Five-lead cable, 2 ft. long, with plug to fit a five-prong (UY) socket. The cable is connected at the factory so that following wires represent the respective prongs of the socket: Blue with white marker—G post of socket; Red—plate of socket; Green—cathode of socket; Yellow—heater adjoining cathode; Black with yellow marker—heater adjoining plate. . . . .Net 65c  
MARCO black bakelite vernier dials. Read 0-100 with a supplementary scale reading 0-10 between figures on large scale. Takes a 1/4" shaft. . . . .Net 50c  
Parts for "A" battery eliminator: Dry rectifier, \$2.10; 0-10 ammeter, 75c; 20-volt filament transformer, \$2.50. Will handle up to 2 amperes filament current.  
**GUARANTY RADIO GOODS CO.**  
143 West 45th St. New York, N. Y.

**BRACH RELAY**—List price \$4.50; our price 99c. Guaranty Radio Goods Co., 143 W. 45th St., N. Y. C.

**A TIME SWITCH FOR YOUR SET**  
  
Those having AC in their homes, whether set is AC operated or not, should use the time switch to turn off the set at any predetermined time up to two hours after setting. Pushing down the owl's head to proper scale position determines time of shut-off. A convenience outlet is built in. Six-foot cable and plug. The owl can be used for any electrical appliance.  
Order Cat. OWL @ \$3.13  
**Direct Radio Co.**  
143 West 45th St., N. Y. City

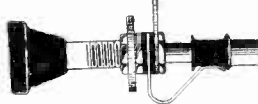
**"A" BATTERY SWITCH**  
  
A push-pull switch for battery-operated sets. Made by Benjamin. Firm, sure contact, extremely long life. Price, 25c.  
**GUARANTY RADIO GOODS CO.**  
143 West 45th St., New York, N. Y.

**DOLLAR SPECIALS!**  
Send \$1 for 8 weeks' trial subscription and get any one of the following premiums free:  
**\$1** Marco Vernier Dial, flat type, with scale suitable for either direction of rotation; auxiliary scale reads finer than main one; both work together. Order PR-MCD. Shipping weight, 1 lb.  
**\$1** 1 mfd. Polymet bypass condenser, 250 volts DC continuous duty rating. Lug connects to positive, case to negative. A sturdy and dependable product. Order PR-POY-1. Shipping weight, 1 lb.  
**\$1** 20-volt transformer; primary, 110 v., 50-60 cycles; secondary will serve as dynamic speaker rectifier transformer or A eliminator transformer, or for six heater tubes with series heaters. Order PR-20-VT. Shipping weight, 4 lbs.  
**\$1** 30-ohm rheostat with switch attached. Useful in battery-operated receivers. One motion actuates both switch and rheostat. Eliminates one panel control. Order PR-30-SR. Shipping weight, 1/4 lb.

**RADIO WORLD**, 145 West 45th Street, New York, N. Y.  
Enclosed please find \$..... for subscription for Radio World for..... weeks. Please send me the premium as indicated below:  
 PB-BT-L-DC \$4 for 35 weeks (8 mos. and 1 week); shipping weight, 1 lb.  
 PR-MCD \$1 for 8 weeks; shipping weight, 1 lb.  
 PR-POY-1 \$1 for 8 weeks; shipping weight, 1 lb.  
 PB-20-VT \$1 for 8 weeks; shipping weight, 4 lbs.  
 PR-30-SR \$1 for 8 weeks; shipping weight, 1/4 lb.  
Name.....  
Address.....  
City..... State.....  
 If renewing an existing subscription for Radio World, please put a cross in square.

**Two** for the price of **One**  
Get a FREE one-year subscription for any ONE of these magazines:  
 RADIO CALL BOOK MAGAZINE AND TECHNICAL REVIEW (monthly, 12 issues)  
 RADIO LOG AND LORE. Quarterly. Full station lists, cross indexed, etc.  
 RADIO (monthly, 12 issues; exclusively trade magazine).  
 RADIO INDEX (monthly, 12 issues) Stations, programs, etc.  
 AMERICAN BOY—YOUTH'S COMPANION (monthly, 12 issues; popular magazine).  
 BOYS' LIFE (monthly, 12 issues; popular magazine).  
Select any one of these magazines and get it FREE for an entire year by sending in a year's subscription for RADIO WORLD at the regular price, \$6.00. Cash in now on this opportunity to get RADIO WORLD WEEKLY, 52 weeks at the standard price for such subscription, plus a full year's subscription for any ONE of the other enumerated magazines FREE! Put a cross in the square next to the magazine of your choice, in the above list, fill out the coupon below, and mail \$6 check, money order or stamps to RADIO WORLD, 145 West 45th Street, New York, N. Y. (Just East of Broadway).  
Your Name.....  
Your Street Address.....  
City..... State.....  
 If renewing an existing or expiring subscription for RADIO WORLD, please put a cross in square at beginning of this sentence.  
 If renewing an existing or expiring subscription for other magazine, please put a cross in square at the beginning of this sentence.  
**RADIO WORLD, 145 West 45th Street, New York, N. Y. ( Just East of Broadway)**

**Three 0.1 mfd. in One Case**  
  
Three Supertone non-inductive fixed condensers of 0.1 mfd. each, (250 v.) in steel case, provided with a 6/32 mounting screw, built in. The black lead is common to the three condensers, the three red leads are the other sides of the respective capacities. Size, 1 1/2" square by 3/8" wide. Order Cat. SUP-31, list price, \$1.00; net price, 57c.  
**GUARANTY RADIO GOODS CO.**  
143 West 45th St., New York, N. Y.

**RECEIVE RADIO WORLD DURING YOUR VACATION**  
Are you going away on vacation for a week, a fortnight, or a month? You will, of course, want to read RADIO WORLD during that period. Send \$1.00 for 8 weeks' subscription, and when you return home we will change your address if you will let us hear from you. RADIO WORLD, 145 W. 45th St., N. Y. City.

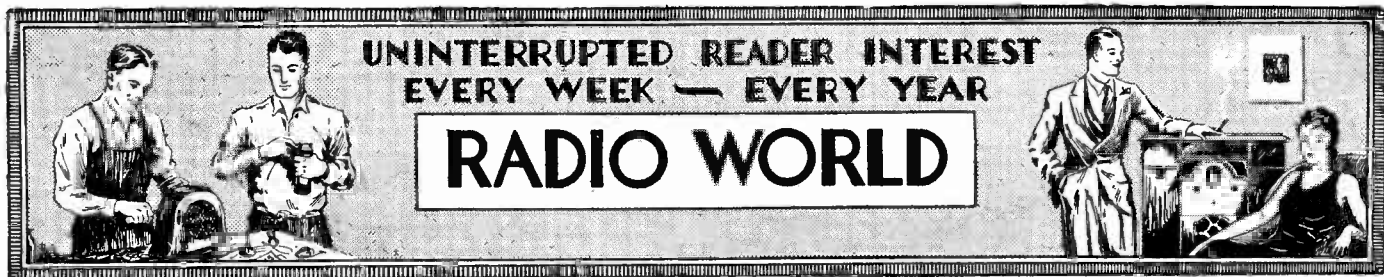

Vol. XIX No. 24 Whole No. 492  
 August 29th, 1931  
 [Entered as second-class matter, March, 1922, at the Post Office at New York, N. Y., under act of March, 1879] 15c per Copy. \$6 per Year.

TENTH YEAR  
 Technical Accuracy Second to None  
 Latest Circuits and News

A Weekly Paper Published by Hennessy Radio Publications Corporation, from Publication Office, 145 West 45th Street, New York, N. Y. (Just East of Broadway) Telephone, BRyant 9-0558 and 9-0559

RADIO WORLD, owned and published by Hennessy Radio Publications Corporation, 145 West 45th Street, New York, N. Y. Roland Burke Hennessy, president and treasurer, 145 West 45th Street, New York, N. Y.; M. B. Hennessy, vice-president, 145 West 45th Street, New York, N. Y.; Herman Bernard, secretary, 145 West 45th Street, New York, N. Y.; Roland Burke Hennessy, editor; Herman Bernard, managing editor; J. E. Anderson, technical editor; L. C. Tobin, Advertising Manager

# Neon Lamp Telephony

## Modulated Light Transmitted in Beam

By J. E. Anderson

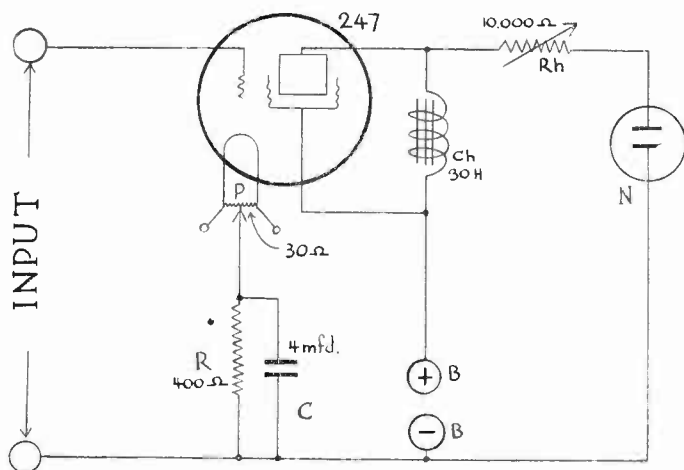

FIG. 1

The circuit of a power amplifier, showing how a neon tube can be connected to the output tube so that the light will be modulated.

TELEPHONY by means of extremely short radio waves and light waves can now be conducted by several methods when the distance between the two points is short and when there are no obstructions between the two points, that is, when the two points are within sight. In a recent issue a system of communication by means of radio waves of the order of 7 inches was described, conducted between Dover, England, and Calais, France. In this system paraboloidal mirrors were used to concentrate the waves in a beam, one of these being used at the transmitter and another at the receiver. Two way communication was effected by duplicating the apparatus.

Recently the General Electric Company conducted telephone communication across the Hudson River between New York and Jersey City, a distance of about 3,000 feet, by means of neon light, using apparatus developed by John Bellamy Taylor in the company's laboratories at Schenectady, N. Y.

### Details Not Available

No details of the apparatus used in this experiment are available at this time, but the general principle employed is well-known. It is applicable not only to neon light but to any light, infrared, visible, and ultra-violet. The only conditions are that the light be capable of modulation by voice frequencies, that a photo-electric cell sensitive to the light used be available, and that the medium between the two points of communication be transparent to the light used. Any light that can be produced can be modulated, photo-electric cells can be produced which are responsive to nearly all light waves that can be produced, and the air is transparent to all light provided the air does not contain too many impurities such as fog and smoke. The longer waves of visible light and the infrared waves pass

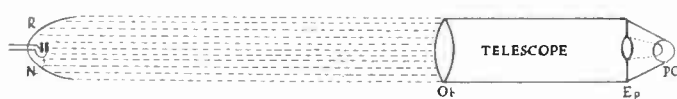

FIG. 2

The light from a neon tube can be transmitted in a beam by means of a paraboloidal reflector and it can be received with a telescope and photo-electric cell.



FIG. 3

The light from a neon tube can also be transmitted in a beam by a simple lens, or lens system, and received by a similar lens and a photo-electric cell.

through even when there is considerable fog and smoke.

Neon light possesses many advantages for telephony purposes. It is easily produced by means of a neon glow tube, it is readily modulated with telephone frequencies, it penetrates fog and smoke better than light of shorter wavelengths, and photo-electric cells sensitive to the light are available.

### Home Experimenting

Those interested in experimenting with neon light telephony can do so in the home or laboratory with very simple equipment, most of which is already at hand. A small neon tube such as those used in small television receivers can be used as the transmitter. The idea is to connect the neon tube to the output of an audio frequency amplifier and thus to vary the light emitted by the neon tube, the variation occurring at audio frequencies. Fig. 1 shows the connection of the neon tube to the power tube in the audio amplifier. While the output tube happens to be a 247 pentode, the connection is the same for any other tube. The choke Ch is a high inductance choke such as would be used if the loudspeaker were used in place of the neon tube N. Rh is a high variable resistance for the purpose of limiting the current in the neon tube.

For experimental purposes it is not necessary to have a microphone because a broadcast signal can be used for modulating the light. The arrangement then would become a sort of delay. Or if a phonograph pick-up is available, the neon tube could be modulated with the sound from a record. Of course, greater thrill will come from using a microphone.

### Concentrating Light

If the neon tube be mounted at the focus of a paraboloidal mirror, such as an automobile headlight reflector, the light could be sent  
 (Continued on next page)

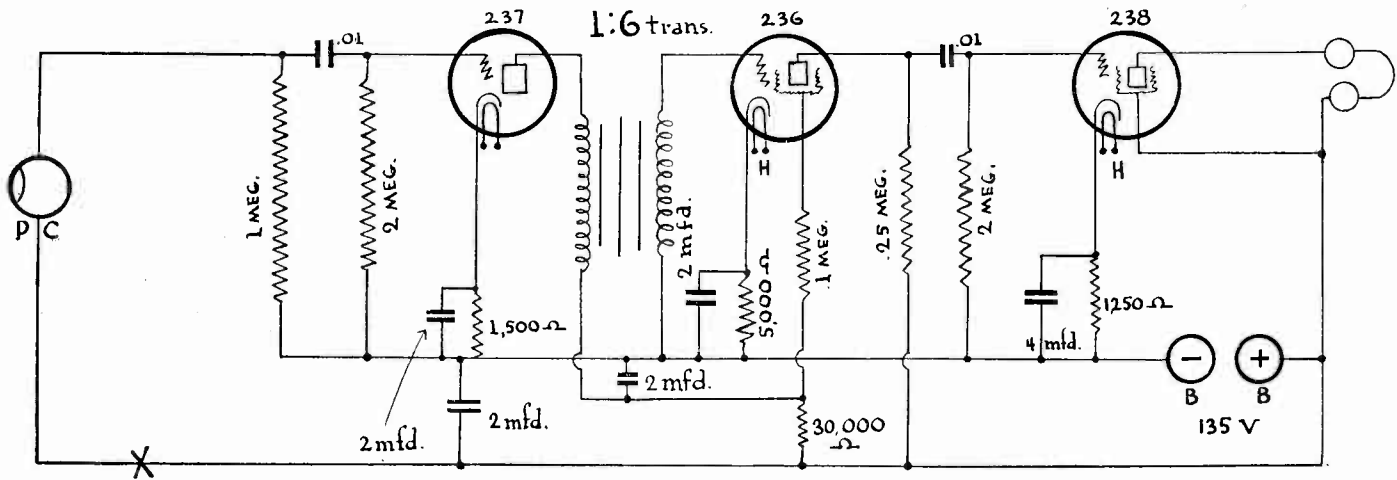

FIG. 4

The circuit of an audio frequency amplifier, showing how the photo-electric tube can be connected. Any good audio frequency amplifier of high gain can be used.

(Continued from preceding page)

in a beam and it could therefore be picked up at a greater distance with a receiver of given sensitivity. But even without a reflector it is possible to receive over any room distance provided a suitable receiver is available.

At the receiving end a similar reflector may be used to intercept as much of the light as possible and concentrating it on a photo-electric cell. But the receiver may also consist of a telescope consisting of a large objective lens for intercepting the light, and a smaller "eyepiece" lens for directing the intercepted light into the opening of a photo-electric cell. Or a single lens may be used by means of which the light from the neon tube is focused on the opening of the photo-electric cell.

In Fig. 2 is shown an optical system containing a paraboloidal reflector R and a neon light N at the transmitting end and a telescope at the receiving end. This telescope consists of the large objective lens Ob, the eyepiece Ep, and the photo-electric cell PC. The main object of the eyepiece in the telescope is to invert the image of the objective, which is upside down. Since it is immaterial whether the light reaching the photo-electric cell is inverted or not it is just as well to use the objective alone and adjusting it so that the light is focused at the opening of the cell.

### Gathering Much Light

If the light in the beam spreads out the amount of light entering the photocell will depend on the diameter of the objective lens. The larger this lens the more light will be intercepted. Comparatively inexpensive lenses 4 inches and more in diameter can be obtained from optical companies, or moving picture equipment supply houses. They are known as condensing lenses. These lenses are plane on one side and spherical on the other.

Fig. 3 shows a possible optical system for transmitting and receiving the modulated light beam. N is the neon light placed so that its luminous plate, which should be the one facing the receiver, is in the focus of the collimating or collecting lenses C. When so arranged, all the light intercepted by the left hand plano-spherical lens is sent out in a parallel beam from the right hand portion of C. Ob is the objective lens which picks up the beam of parallel light and brings it to focus on the photo-electric cell PC.

It is well to mount the objective and the photo-cell so that no light that has not passed through the objective enters the cell. In other words, the lens and the cell are put in a box similar to a camera.

While there are four plano-spherical lenses in this system, two at the transmitter and two at the receiver, it is feasible to use two lenses each having two spherical surfaces, that is, ordinary magnifying lenses. Such lenses from 2 to 3 inches in diameter can be obtained at a very low price.

For experimental purposes in the laboratory or the home elaborate equipment is not necessary. The essential components of the transmitter are a source of sound, an audio frequency amplifier, a neon tube, an optical system for sending out a beam of light, the simplest of which is a magnifying glass of fairly large size. The essential components of the receiver are a lens for collecting and focusing the light, and this lens may be similar to the transmitting lens, a photo-electric cell sensitive to the neon light, and an audio frequency amplifier.

### Amplifier for Photo-cell Output

In Fig. 4 is the circuit of an amplifier that is suitable for amplification of the output of the photo-electric cell. It employs one 237 tube in the first stage, a 236 in the second, and a 238 in the output stage. A pair of headphones are shown to be connected but a loud-speaker may be used instead. A transformer is used as one of the couplers in order to reduce the chance of motorboating at low audio frequencies, and for the same reason the first tube is a three element, low mu tube.

The various constants necessary for the construction of the amplifier are given on the diagram. It must not be assumed that these must be used and that any others would be wrong. Considerable variation may be allowed in most of them but the values given are typical. The highest voltage in the circuit is 135 volts. It may be that the photo-cell used requires a higher or a lower voltage. A higher voltage may be applied by connecting a battery in series with the photo-cell alone, the negative of this battery being connected to the positive 135 and the positive to the anode of the cell. The point marked X is suitable for the insertion of the booster battery. If the voltage is too high for the cell used, the anode of the cell can be connected to a suitable point on the voltage divider of the B supply, or to a tap on the 30,000 ohm resistance.

A suitable photo-cell can be obtained from any one of several tube manufacturers. The best cell for this purpose is a gaseous cell, for this is much more sensitive than the high vacuum cell. A cell sensitive to red and orange light is also recommended, such as a caesium cell. Photo-electric tubes are now obtainable at reasonable prices.

### Simplicity of Light Telephony

Telephoning by means of light is much simpler for the amateur experimenter than telephoning by means of ultra-short radio waves. The equipment is simpler to construct, less expensive by far, and is not subject to nearly as many technical difficulties. The simplicity is due to the absence of tuned circuits. Yet the optical principles involved are exactly the same. It will be noted that in telephony by neon light, or any other light, there is no radio frequency involved. The signal is always at audio frequency.

Communication can only be conducted between two points which are in sight of each other. Any opaque obstruction between the two points will prevent communication. For example, if the experiment is conducted in the laboratory the signals may be stopped by putting the hand in the path of the beam of light. It is clear, however, that where it is necessary to go around an obstacle or around a corner, the beam may be directed by means of plane mirrors. By this means it would be possible to have the transmitter on one floor and the receiver on another. It would only be necessary to direct the beam of light through the window to a mirror set so as to deflect the beam upward. At a higher window there would be another mirror to intercept the beam and direct it into the room.

### Applications

Telephony by means of light beams possesses some advantages over telephony by wire circuits or radio. It is not subject to any interference from natural and man-made electrical disturbances. It is not subject to cross talk, for any number of light beams could cross without blending.

However, these advantages are not great enough to overcome the advantages radio and wire telephony possess. It is much easier to direct an audio signal by wire than by mirrors and the set-up of a wire circuit would cost less. Over radio it possesses the added advantage that no license is necessary to communicate.

Telephony by mean of light is useful in cases where no wires can be strung without great expense or not at all. For example, it would not be practical to lay a wire cable across a river or a narrow body of water for a single communication channel. By means of light a channel could be set up without difficulty. Of course, a radio channel would span the distance just as well but this would require a license to transmit, and the license would probably not be available for a private channel. There are also cases where communication is necessary between two mountains where the territory between is almost impenetrable. Surveyors now use light for communication, either by means of search lights or heliographs. But these are practically limited to code.

Whether or not the neon light method of telephony is practical or not, a great deal of fun can be derived from playing with it.

# Correct Way to Solder

## Follow the Rules or You'll Get Into Trouble

By Einar Andrews

**S**OLDERING is not a difficult operation if the work is done correctly. But if it is not so done it may be quite impossible to solder two surfaces together, or even two pieces of wire. There are certain rules that must be complied with if the work is to be done neatly.

The first rule is that the surfaces to be soldered together must be clean. All non-metallic, and some metallic, materials must be removed before the solder will stick. Material such as nickel plate, enamel, granite, varnish, rubber, fabric insulation, and products of corrosion must be removed, not partly but completely. If solder is applied to an unclean surface it will not stick no matter how much heat is applied. If the surfaces are scrupulously clean it will stick easily just as soon as the work is above solder-melting heat. The surfaces must be cleaned with sandpaper or similar abrasive, with a knife or a file.

Many of the materials preventing good soldering listed above are not met with in radio work, but are often encountered in the kitchen, on the farm, or in the machine shop. The impurities met in radio work is practically limited to rubber, varnish, fabric insulation, sulphides, and oxides. The sulphides and oxides form on metals when they are exposed to oxygen and sulphur fumes. On some metals these corrosion products form so rapidly that it is even impossible to clean the surfaces, and hence impossible to solder. This applies to aluminum. Copper, iron, brass, zinc, which are most common in radio sets, can be cleaned easily and they stay clean long enough for the solder to be applied.

### Heat Required

A necessary requirement for good soldering, for any soldering, is that the work be heated above the solder-melting temperature. It is not necessary that the entire work be so heated. Indeed, that is not even desirable when it is practicable. It is only necessary to heat those parts which are to be soldered, and the heat should be concentrated in a space as small as practicable. Soldering often fails because the heat is dissipated, carried away by metals. This often gives rise, not only to poorly soldered joints, but to burned insulation and damaged parts. This often results when the surfaces to be joined are not clean, for it is then necessary to hold the iron to the work longer than it would otherwise be necessary. And the result is not a soldered joint, but damaged work. Even an iron that is too cold for good soldering will often cause this result of overheating parts that should not be heated. The under heated iron is held too long to the work and the heat is carried to parts that can be damaged with less than solder heat.

One of the necessary requirements is that the soldering iron be large enough to carry sufficient heat. Much work may be damaged by an iron so small that it is not able to heat the work to solder heat, but just enough to heat and burn rubber insulation, bakelite, or wood. The heat from the iron flows into the metal work just as fast as it is generated and no solder-melting heat is attained. A large iron will not only generate more heat but it will retain more heat to be used at a point quickly. The spot immediate the joint to be soldered if raised above the solder-melting temperature much of it can flow into the rest of the metal work.

If the joint is clean and the solder applied quickly, the work is done before any appreciable heat has carried into the work and no damage is done, but a good joint is produced. The

size of the iron to use depends on the dimensions of the metals to be soldered. A small iron will do to join two small wires, but it takes a big one to solder two brass plates together. Even for small work there is no good reason for using a small iron, except when the joints to be soldered are inaccessible with a large iron.

### Clean Iron Essential

A clean soldering iron is just as essential as a clean joint. The copper surfaces of the iron should be covered with a layer of clean solder, not with a layer of burned flux or solder slag. Overheating of the iron for considerable time will cause oxides to form on the solder covering the surfaces. These will foul the work and they will also prevent the heat from flowing from the iron to the work. Just before applying the iron to the work the surfaces on the iron should be wiped with a cloth and fresh solder should be applied. This will facilitate the work and make a neater joint. It should be remembered that the molten solder should flow almost like water into the work. It will not so flow if the solder on the iron is covered with a layer of oxide that acts like a water tight bag. That is, the oxide not only prevents the heat from flowing from the iron to the work but it also prevents the molten solder itself from flowing. The film of oxide will particularly prevent the solder from flowing into small crevices.

The fresh solder should be applied to the work and not to the iron, assuming that the iron is well covered with fresh clean solder. If the solder to be applied to work is first put on the iron, the flux is destroyed and the residue may hinder the work rather than aid it.

A good flux is essential to good soldering. The flux serves to prevent the formation of oxides and other products of the metals involved. That is to say, it prevents the formation of the film referred to above, and it prevents the formation both on the iron and on the work. It keeps the molten solder in a state of flux and not in a bag, and that is the reason it is called flux.

### Apply Solder to Work

For radio work the best flux is rosin because this does not attack the surfaces. Rosin core solder is the most convenient. For heavy work it may be necessary to use acid flux, for this has greater fluxing properties. But when acid flux, or any flux that causes corrosion, has been used it is necessary to clean both the work and the iron very thoroughly after the job is done. A tiny drop of acid left on the surface of the soldering iron will dig a deep pit in the copper and the iron will be ruined quickly unless all acid is removed completely as soon as the work is completed. The same applies to the work. The acid will dig into that just as much as it will dig into the iron, and if there is any appreciable digging the work will be weakened if not completely ruined.

The acid should be washed off with water. While the effect of the acid may be neutralized with alkali, if there is an excess of alkali this will cause corrosion. After the washing the work should be dried quickly. Of course, these precautions are not always observed, but they are well worth while in most instances. A badly pocked iron, for example, is not useful while it is in that condition and it is not easy to put it in condition.

## Short-Wave Club

[Herewith is a list of new members of the Short-Wave Club. Any reader may join without obligation.]

Albert B. Wetmore, 86 Ray St., Portland, Maine  
 Wm. M. Child, 231 Knox St., Rumford, Maine  
 Harold L. Tellis, 453 East 175th St., New York, N. Y.  
 Leo F. Wick, Box 169, Weimar, Tex.  
 John Rau, 1460 West 54th St., Cleveland, Ohio  
 Emerson B. Link, 753 E. Big Bend Rd., Webster Groves, Md.  
 Robert L. Casper, 1709 Irwin St., Aliquippa, Pa.  
 R. A. Snyder, 108 Liberty St., Peoria, Ill.  
 Albert Cleary, 338 Arsenal St., Watertown, N. Y.  
 P. J. Aubin, care of Paul's Radio Ser., 3 Water St., Putnam, Conn.  
 Charles Lindley Woodbard, 371 Washington St., Braintree, Mass.  
 Joseph Meites, 711 Patee St., St. Joseph, Mo.  
 Albert C. J. Miller, 2419 Lockbourne Rd., Columbus, Ohio  
 Roy R. Roush, Box 213, Edgerton, Wyo.  
 Frank Williams, 746 N. 14th St., East St. Louis, Ill.  
 W5BUY, 509 Pile St., Clovis, N. Mex.  
 E. A. Holmes, 3013 Presbury St., Baltimore, Md.  
 Walter Roger Stempel, 4704 South Justine St., Chicago, Ill.

Robert J. Cardwell, Box 282, Oceanport, N. J.  
 Sal Improta, 433 E. 121st St., New York, N. Y.  
 Frank Dewar, 143 Morris Ave., Selkirk, Man. Can.  
 Jack Morris, 154 Cotr St., Antoine Rd., Westmount, Que., Can.  
 Rob't. Gums, Jr., 6838 Dorchester Ave., Chicago, Ill.  
 Kenneth Barton, 1301 Washington St., Amarillo, Tex.  
 K. E. Parker, U. S. S. Mississippi, Box E-14, Portsmouth, Va.  
 Harry Otis Lutmark, care of A. G. Lutmark, Alderwood Manor, Wash.  
 Chas. H. Reinhardt, 12151 Findlay St., Detroit, Mich.  
 Clinton Nevada Safford, R. F. D. No. 4, Saint Johnsbury, Vt.  
 W. E. Jordan, 4 State St., Oil City, Pa.  
 David D. Sanders, P. O. Box 321, Spartanburg, S. C.  
 Kenneth Cary, R. F. D. No. 3, Gansevoort, N. Y.  
 Harold R. White, Hall's Ground, R. F. D. 2, North Adams, Mass.  
 Hague's Service Station, 101 W. Division St., Neillsville, Wis.  
 W. F. Geiger, 302 W. Cherry St., Winslow, Ariz.  
 John M. Bruckart, Talmage, Pa.  
 E. G. Robinson, Box 85, Midlothian, Ill.  
 George C. Anderson, 2236 Indiana Ave., St. Louis, Mo.  
 Murray Martin, 167 Gladstone Ave., Toronto, Ont., Can.  
 Wm. B. Venables, 504 Neville St., Pittsburgh, Pa.  
 Carroll Cranow, Box 100, Nevada City, Calif.

# A Three Tube Midget

## Everything Housed in Cabinet Form

By H. C.

THE modern midget receiver owes a great deal of its popularity and success to important developments in three distinct fields: first in tubes, second in circuits, and third in parts and accessories. The screen grid tube, the variable mu and the power pentode have all contributed to the high efficiency of present day radio sets. The latest circuits, such as the one employed in the Pentode Three Midget, make it possible to utilize these tubes to the fullest extent, thus eliminating many components formerly regarded as essential and also reducing the number of tubes to a new minimum. Parts and accessories have also been designed recently especially for use in midget sets. As a result, the entire Pentode Three Midget set, including dynamic speaker, can be housed comfortably in a cabinet formerly used for only a dynamic speaker.

The circuit consists of a tuned radio frequency stage, using a 551 variable mu tube; a 124 screen grid power detector and a single audio output stage, using a 147 pentode. The control grid of the pentode is directly coupled to the plate of the screen grid detector, using the Loftin-White system. A 180-type full-wave rectifier is employed. The dynamic speaker field is used instead of an audio choke, to filter the rectified a-c and the design is such that hum is entirely eliminated. An Anperite is used to give automatic regulation and control of line voltage. The circuit is designed to use a variable mu tube at (5) to attain extra selectivity and to eliminate crosstalk. Slight changes in the values of the Durham metallized resistors at (28) and (29) permit the use of a 124 tube instead of the variable mu tube.

Binding posts at (18) and (18A) permit the use of a phono pick-up in the circuit. A two-button Universal microphone may also be connected, employing the No. 1152 input transformer with its secondary connected between (18) and (18A). A 1½-volt dry cell is required by the microphone. This permits the use of the receiver for making announcements, etc. Volume is controlled by means of a cathode series resistor at (10). The antenna coupler and the r-f transformer are Conoid coils, designed especially for use in midget sets. These coils are completely shielded, being enclosed in copper cases having removable bases. They are air-wound and self-supporting and are very accurate and selective. These coils are only 2 inches in diameter and 1½ inches high.

The two coils are tuned by a two-gang DeJur-Amsco midget special variable condenser. It permits ready mounting on the midget chassis. The steel frame and shield parts are of unusual thickness. Hence there is a reduction of sound transmission, eliminating the tendency of the plate to vibrate at audio frequencies. This con-

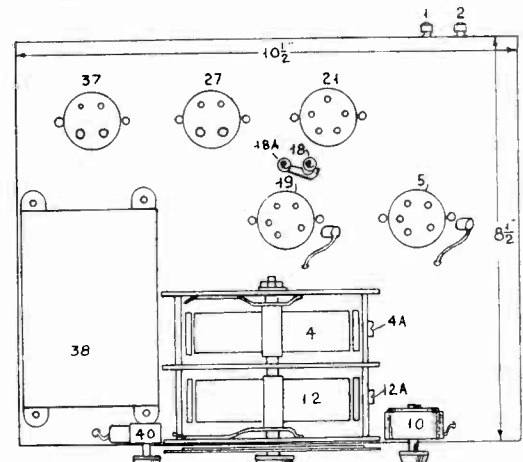
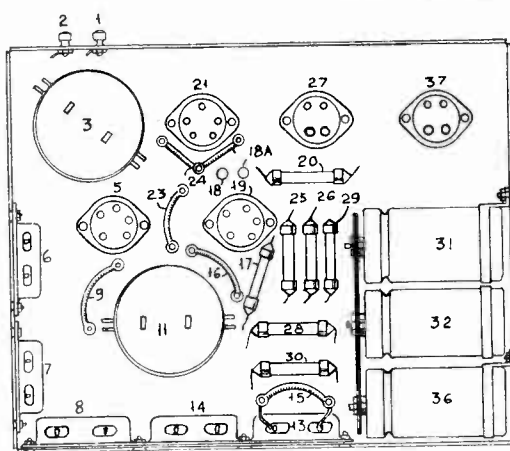
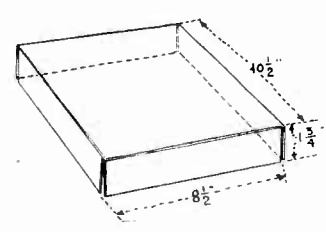
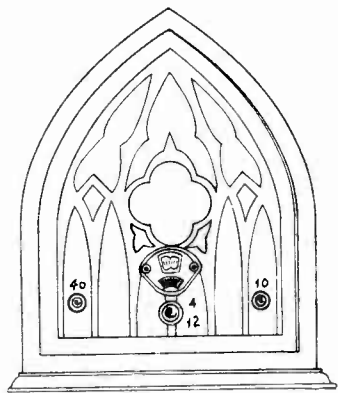
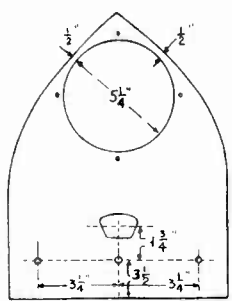
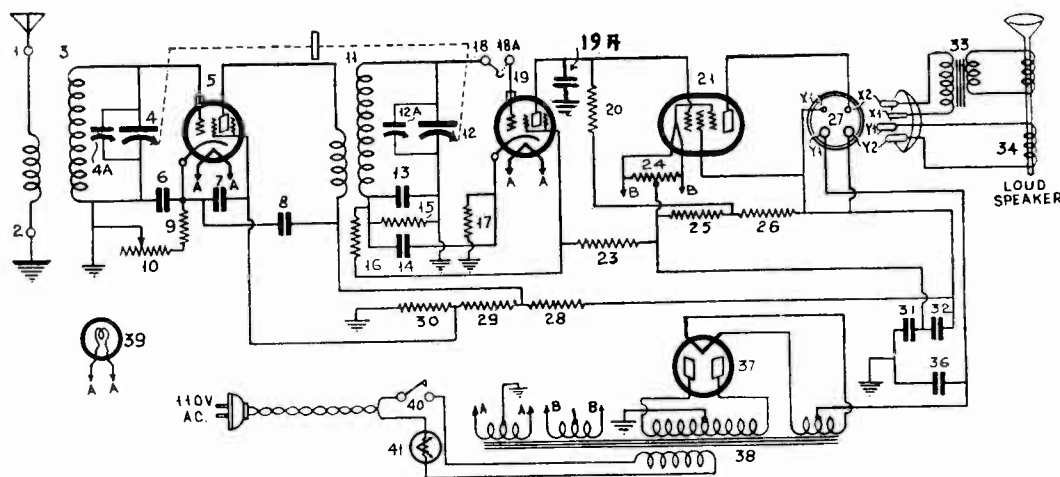

The circuit diagram is at top, with numerals designating parts, corresponding to mention of these parts in the text. At left on the next tier are the outside cabinet dimensions, in center the front view, at right the chassis dimensions. At bottom, left, the under new of chassis parts, at right the upper view.

sideration is of the utmost importance where the speaker is mounted close to the tuning unit. If not taken care of in this way, the tuning condenser often functions as a condenser microphone, setting up a sustained howl. The dry electrolytic condensers specified are also well adapted for midget set requirements. They have a direct current working voltage of 450 volts, but are only 1¾ inches in diameter by about 2½ inches long. The metal case fixed condensers (bypass) are also very compact. Another feature of this set is the use of the new midget Utah speaker, one of the smallest but finest dynamic reproducers available. Details of the assembly and wiring of the "Pentode Three Midget" will be given in the next article. A very small aluminum chassis is used with the Corwico Braidite hook-up wire entirely concealed below the deck.

The chassis of this receiver is made from a piece of 14 gauge aluminum, 11x13 inches. Any tinsmith is equipped to bend the four

# get with Rectifier

## erly Used Only for a Speaker!

### Cisin

sides at right angles, to form a chassis  $1\frac{3}{4}$  inches high, by  $9\frac{1}{2}$  inches wide, by  $7\frac{1}{2}$  inches deep. The width and depth are correctly marked in the illustrations. The five socket holes are drilled first and the sockets are mounted from the underside. Space may be conserved by laying out the socket mounting holes diagonally at an angle of 45 degrees, instead of parallel with the back of the chassis.

#### Mechanical Directions

The power transformer is mounted next, then the two-gang variable condenser, putting it as close to the transformer as possible. Holes are drilled at the left and right front of the chassis respectively, for the switch and volume control leads. A hole is drilled alongside of socket (19), for the control grid lead, which connects from binding post (18A) to the cap of tube (19). The binding posts are mounted next, using two duplex binding post strips. Aerial and ground posts are mounted on the rear side wall of the chassis, while the "phono" posts are mounted as indicated or else to the right of socket (5).

A hole is drilled in the rear side wall and a grommet is inserted to insulate the outgoing 110-volt leads from the chassis. The chassis

#### LIST OF PARTS

- One 0.0001 mfd. Aerovox fixed Mica Condenser (19A)
- One 2 mfd. Aerovox By Pass Condenser (6)
- One 4 mfd. Aerovox Electrolytic Condenser, type E5-4 (36)
- Four .1 mfd. Aerovox Metal Case Fixed Condensers, type 260 (7, 8, 13, 14)
- Two 1 mfd. Aerovox Electrolytic Condensers, type E5-1, with M't'g Rings (31, 32)
- One 0.00035 mfd. DeJur-Amsco "Midget Special" two-gang Variable Condenser, type 3702-D—(4, 12)—Equalizing Condensers on Variable Cond. (4A, 12A)
- One DeJur-Amsco Direct-drive Dial, type XTRAC, with Escutcheon and dial light socket.
- One Electrad Volume Control, type RI-202 (10)
- One 200-ohm Electrad Wire Grid Resistor (16)
- One 300-ohm Electrad Wire Grid Resistor (15)
- One 400-ohm Electrad Wire Grid Resistor (9)
- One Electrad Truvolt Center-tap Resistor, type V-20 (24)
- One Electrad Truvolt Flexible Resistor, type 2G-3500 (23) ...
- One Trutest Loftin-White Power and Filament Transformer, type LW245 (38)
- One 10,000 ohm Durham Metallized Resistor Powerohm, type M. F. 4 (1 watt) (30)
- One 10,000 ohm Durham Metallized Resistor Powerohm, type M. R. 4 (2 watts) (28)
- One 15,000 ohm Durham Metallized Resistor Powerohm, type M. R. 4 (2 watts) (29)
- Two 50,000 ohm Durham Metallized Resistor Powerohms, type M. F. 4 (17, 25)
- One 100,000 ohm Durham Metallized Resistor Powerohm, type M. F. 4 (26)
- One 500,000 ohm Durham Metallized Resistor Powerohm, type M. F. 4 (20)
- One "Conoid" Shielded Antenna Coupler (3)
- One "Conoid" Shielded R.F. Coil (11)
- Three 5-Prong Sockets, wafer-type (5), (19), (21)
- Three 4-Prong Sockets, wafer-type (27), (37), (41)
- One 4-Prong Plug (for speaker) (27)
- One Amperite Self-Adjusting Line Voltage Regulator (41)
- One Power Switch (H. & H. toggle type) (40)
- One  $2\frac{1}{2}$ -volt Dial Light (39)
- Four Binding Posts (1, 2, 18, 18A)
- One Roll Corwico Braidite Hook-up Wire, Solid Core
- One 551 Arcturus Variable Mu Tube (5), or a 124 Arcturus Screen Grid Tube (5)
- One 124 Arcturus Screen Grid Tube (19)
- One PZ Arcturus Pentode Power Tube (21)
- One 180 Arcturus Full-Wave Rectifier Tube (37)
- One Utah Midget Dynamic Speaker, new smallest diameter type, 750 ohm field (34), with pentode-type output transformer (33)
- One Aluminum Sheet, 12 to 14 gauge, bent on four sides to form chassis  $7\frac{1}{2}$ " x  $9\frac{1}{2}$ " x  $1\frac{3}{4}$ " high
- One Wood Baffle cut to fit inside of cabinet, with holes as indicated on "Inside Panel Details" sketch
- One Peerless Cabinet

NOTE: Numbers in parentheses refer to corresponding numbers on diagrams.

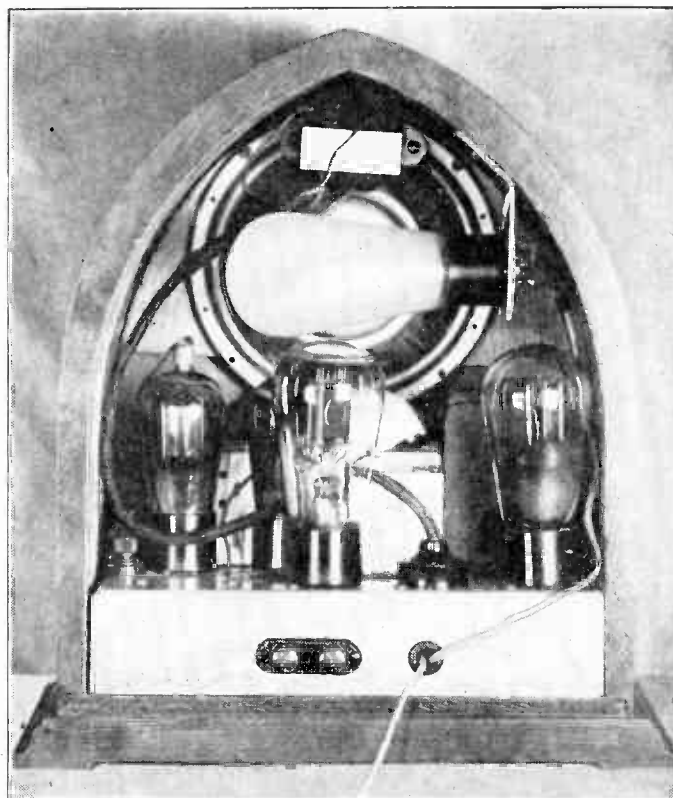

Rear view of the completed receiver

is then turned upside down and the five by-pass condensers are mounted on the inside chassis walls. Next the electrolytic condensers are fastened in place. The two outside condensers are secured to the chassis side wall in the usual way, by means of mounting rings. The center condenser (32) must be insulated from the chassis. Hence a bakelite strip 1 inch wide by about 4 inches long is fastened between the center terminals of the two outside condensers and the center condenser is then held in place by securing its central terminal to the bakelite strip. All holes in the side of the chassis must be countersunk and flat-headed fastening screws must be used, as otherwise chassis will not fit into the cabinet.

The coil shield bottoms are mounted and the shield tops containing the coils are slipped into place. Resistors (17, 20, 25, 26, 28, 29, 30) should be mounted parallel to each other on a thin fiber strip. They are held in place by pushing the pigtail connectors through small holes drilled in the fiber. Resistors which are to be connected together are soldered in place.

The others which require external connections are provided with suitable leads of flexible Braidite. Five-watt resistors will give best service at (28), (29) and (30).

#### Other Connections

All wiring should be performed as far as possible before fastening the resistor strip in place. Corwico Braidite wiring may be used, as this wire, with its distinctive push-back feature, is especially adapted for use where space is limited. The order of wiring is as follows: filament, grid, plate, cathode, negative returns and by-pass condensers, antenna coil primary to posts (1) and (2), rectifier connections, electrolytic condensers, primary of power supply transformer to leads going to switch, plug and amperite socket. Both volume control (10) and switch (40) are connected at the ends of 2-inch flexible leads brought up through the chassis. The resistance strip is fastened in place beneath the chassis about 1 inch from the bottom, being located directly beneath the variable two-gang condenser. Connections to these resistors are then completed.

The dial light is wired in. Two sets of leads are carried through the rubber grommet at the rear: one for the plug to the 110-volt source, the other going to the amperite socket. The latter is fastened to a strip of wood or metal, which in turn is secured at the upper rear of the cabinet, so that the amperite is held in a horizontal

(Continued on next page)

# Taming Resistance Audio

## Results of Experiments Given—

By Hap

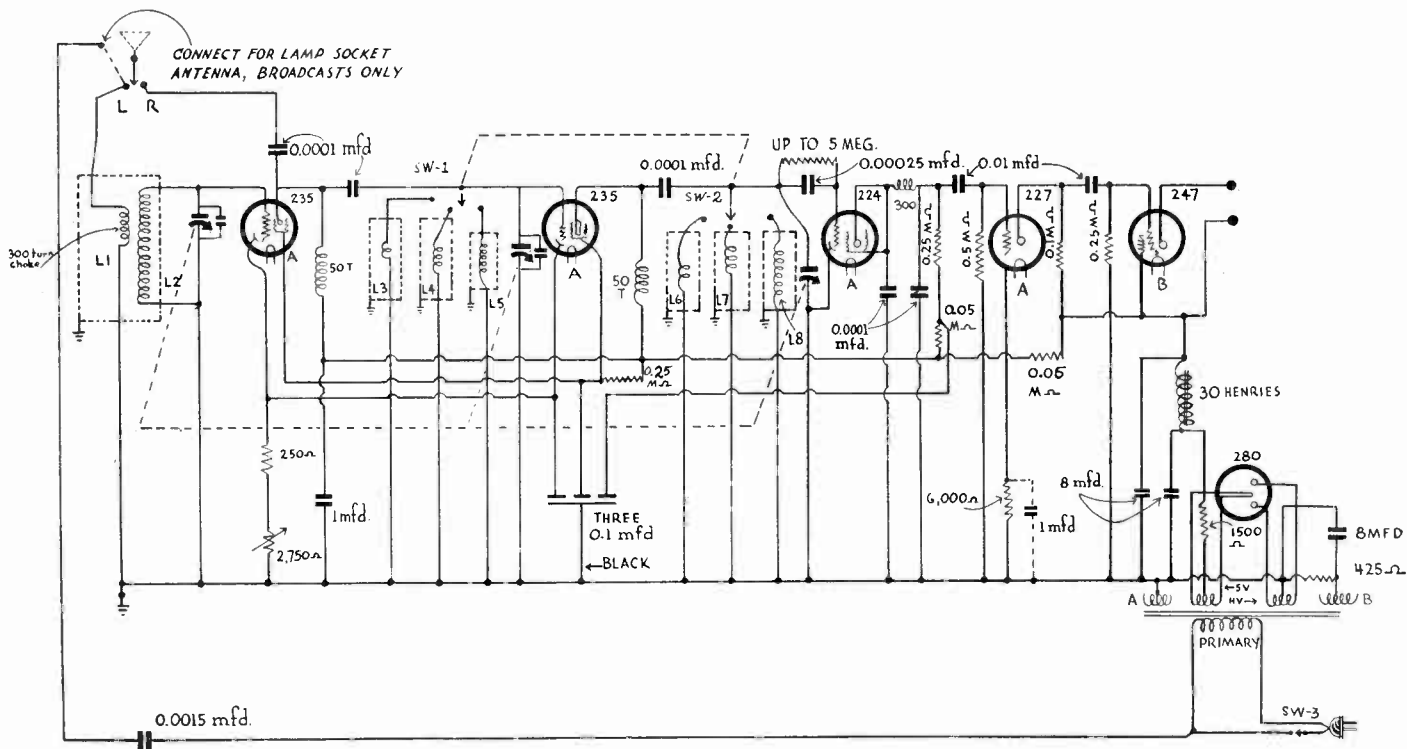

FIG. 1

A 6-tube all-wave set (including rectifier). A light socket antenna system may be used to advantage in some locations (see fixed condenser 0.0015 mfd. at bottom). A wire across two posts would put it in circuit.

[In last week's issue, dated August 22d, an eight-tube circuit was discussed, on the basis of utilizing as many as possible of parts you now have. It was alternating-current operated, with an untuned first stage of radio frequency amplification, two tuned stages, and a tuned detector input, with resistance coupled first audio and push-pull pentode output (247's). The rectifier was a 280. All-wave coverage was provided, about 30 to 550 meters, by a four-point triple throw switch shorting out secondary turns of all three tuned circuits. Another switch moved antenna from the choke coil at the input to the plate of the next tube for short waves. See page 10 this week. Above a six-tube circuit is shown, with separate coils picked up by the wave-band switch, and with single-sided output. —EDITOR.]

**H**OW to get the most out of a six-tube circuit (including rectifier), using so far as possible parts you have already, is the topic this week. The object is to reconcile the different requirements with the possibilities, so that a practical all-wave tuned radio frequency receiver will result.

The radio channel consists of two tuned stages of amplification, with a tuned detector input, using a three-gang condenser. The aerial is connected to the choke primary of the antenna coupler for broadcast reception, whereas for short waves it is connected instead to the primary of what was formerly the first interstage coupler, whereupon that second transformer becomes the antenna coupler. The r-f choke coil is used as antenna primary in one instance to build up the input at low radio frequencies of the broadcast band.

### Using Different, Selective Capacities

The shift of antenna connections may be made readily, using either two binding posts on the chassis, and connecting the aerial to one or the other, or, if front panel shifting is desired, this may be accomplished by putting a single pole double throw switch on the front, or by using a three-deck rotary switch, instead of a two-deck type, with position (3) of the extra deck of this switch connecting aerial to L1, at point L, while the two other positions connect the aerial instead to position R, the 0.0015 mfd. condenser.

If desired, three different capacity condensers could be used with the three-decked switch so that the effective capacity would be cut down for the higher frequencies. For instance, three fixed condensers would be connected to plate with the other sides open. One would be 0.00025 mfd., corresponding to position (3), another would be 0.0001 mfd., in use for position (2), while for the smallest inductance used in the tuned circuit, position (1), of the switch, 0.00005 mfd. may be used, which may be an equalizer of 20-100 mmfd. set once. The positions cited numerically correspond to coil tab positions for the two other decks of the switch.

Let us investigate the effect of discarding the first tuned stage on short waves and using only one stage of radio frequency amplification, done because of simplicity.

### Why No Trapping Results

The tuning circuit is left intact in the first stage, but the antenna input is taken away. This does not alter the fact that the first stage remains tuned. However, the tuning is in the broadcast band. Therefore as the two other tuned circuits under the condition imposed will be in short-wave bands, the first stage though tuned, is not in resonance with other tuned circuits. Also, the high resistance of the tube is between the two stages. The frequencies are so far apart that there is no danger whatsoever of the first circuit acting

## Wiring Directions for

(Other Illustrations on Front Cover)

position over the chassis. The inside panel is made of 3-ply wood, cut so as to fit within the cabinet.

A hole is cut for the speaker and this is mounted on the inside panel. Holes are also cut for the dial opening, the condenser shaft, for mounting switch and volume control. The dial is fastened on the shaft. Holes are cut in the front of the cabinet for the escutcheon plate and for the projecting shafts of variable condenser,



# in a Salvage-Parts Set

## Tuner Provides All-Wave Coverage

### good Force

as a trap to short-wave signals. Indeed, it is a trap only to broadcast signals.

#### Frequency Comparison

Assume that the broadcast coverage is from 200 to 600 meters, accomplished without disturbing the switch from position (4), which is a point not electrically in circuit, because no turns are to be shorted out. It is a sort of end stop or resting place. The wavelength ratio is 1-to-3. Assume the same ratio for the next band. Then the coverage would be from 200 to 66.66 meters. When 200 meters is tuned in, the condenser plates are totally enmeshed, that is, the dial may be read 100. At the same time the first stage, which remains at broadcast frequencies, would be tuned to 600 meters. The difference is 400 meters. No chance of any trapping out of short waves with such a great difference in wavelength in this region.

Now, take the other extreme, of 66.66 meters. The dial would read 0. The broadcast frequency for the first stage at 0 would be, say, 200 meters. The difference is 133.33 meters. No chance of trapping out short waves here. The frequency difference between 200 meters and 133.33 meters is far too great.

Perhaps we should have considered the frequency difference in the first place. Let us do so now.

When the respective circuits are tuned to 600 meters and 200 meters, the frequencies being 499.7 kc and 1,499 kc, the difference is 999.3 kc. When the circuits are tuned to 200 meters and 66.6 meters the frequencies are 1,499 kc and 4,500 kc and the difference is 3,001 kc. It can be seen the difference is about three times as great for the 0 dial setting as for the 100 dial setting. And as still shorter waves or higher frequencies are tuned in (using the next pair of taps), of course the frequency difference is far greater.

#### Rheostat for Volume Control

The volume control in the present instance is a high resistance rheostat that increases the grid bias. The change in bias is far greater this way than if the screen voltage were altered. Either method works well, however, and the only object is to show an option in conjunction with the method used in last week's circuit. Also, a wire-wound rheostat may be used, because of lower resistance value, and this gets away from one possibility of trouble. Some commercial rheostats have a total of 3,000 ohms, with a 250 ohm minimum, making the adjustable portion 2,750 ohms.

The first tube remains in the direct current circuit even when short waves are tuned in, and this is a good point, because then the biasing may be altered just the same by the rheostat, otherwise the minimum bias would be halved and the change therefrom would be halved, due to the current flow being halved.

Both the radio frequency amplifier tubes are tied to the volume control, the resistance network interrupting the plate-screen currents' path to ground. The minimum bias is about 3.5 volts (required to prevent squealing) and the resistance increase may multiply that bias by about 10, or the bias may vary from 3.5 to 25 volts negative. There is still some amplification left in the 235 tube even if the bias is 45 volts negative, so we are not pressing the bias too hard.

When short waves are tuned in the control's effects includes the only tube in the active radio amplifier.

#### The Audio Circuit

Now we come to the audio channel, which is resistance coupled. Whenever resistance audio is mentioned it is well to discuss intimately the values of constants and to report on the results obtained because of the audio frequency instability that attends resistance coupled channels that are not properly designed.

It will be noticed that there is a dotted line for a bypass condenser across the resistor of 6,000 ohms that biases the first audio frequency tube (227). The feedback in a biasing resistor is nega-

tive, therefore a bypass condenser is always used if it is desired to avoid or greatly reduce negative feedback.

When the detector plate resistor (224 tube) was 0.25 meg. (250,000 ohms), the grid leak in the first audio stage 0.5 meg., the plate resistor in the first audio stage (227) 0.1 meg. (100,000 ohms) and the grid leak in the pentode circuit 0.5 meg., there was motorboating at a frequency of about 20 cycles per second. It was not severe, but it was enough to modulate the signal objectionably.

Here we had a case of positive feedback at a low audio frequency, and that proved that the audio channel was a greater amplifier at the low frequencies than at the high, so any means to make the amplification substantially even would be justified. The motorboating was cured when the 0.5 meg. was replaced by an 0.25 meg. The motorboating resumed if this resistor exceeded 0.35 meg. These seem like very low value for grid leaks, and indeed are, but not too low, as the performance proved. The circuit became immediately stable at audio frequencies.

#### More Audio Oscillation

Now, negative feedback being acknowledged in the 6,000 ohm resistor, if a condenser were put across this resistor we might also have radio frequency oscillation, since resistance coupling is a good radio frequency amplifier. Include a 1 mfd. condenser unless squealing is suffered.

Facts such as these show up on experimentation. The best equation for resistance audio is: results equal hands plus ear.

For determination of stability a milliammeter in the plate circuit of the pentode tube will disclose, by its oscillating needle, the presence of slow motorboating, while the ear of course hears this, too. The speaker must be in circuit. For higher frequencies than 100 cycles the effect on the needle is so small that the ear should be the guide. The object of using a meter is to watch the cure being effected on low frequencies and to have a good means of verifying complete cure, which the ear will not do.

If any condensers have been spared in the radio frequency amplifier, detector and first audio stages, the omission, purposeful though it be is atoned for the filter and the pentode stage. The capacity from the ends of the B supply choke coil to ground are 8 mfd. each, while the capacity across the biasing resistor is of the same value.

The detector may have screen grid and plate united, and high voltage applied provided the leak value is low. The lower the value the less output, so squealing may be corrected with low values.

Although 0.01 mfd. is marked for this isolating condenser, the value used may be larger.

#### Why a 227 For First Audio?

The circumstances so far outlined justify the use of the 227 tube as first audio amplifier, since even with its limited amplification (about 8 times) there was motorboating that had to be remedied, so it would be of no use in this circuit to include a screen grid tube in this position. If the amplification is heightened, so is the feedback.

The capacity developed in the plate circuit when a 227 tube is used even with a load of 0.1 meg. is large enough to serve as a bypass for radio frequencies, and the higher the radio frequencies the greater the effect, so that the radio frequencies that may have escaped from the detector are not amplified in the pentode tube that provides most of the audio amplification (95 as compared to 8 for the 227). Also, the unbypassed resistor puts an effective obstacle in the way of radio frequencies, so the pentode is spared these.

The audio gain therefore may be estimated at 760, as applying to an ideal condition. However, the low leak value in the pentode audio circuit reduces this, and the gain is about 500 actually. With a suitably sensitive radio amplifier—such as the one to which this audio channel is connected—a gain of 500 is satisfactory. Low-ratio audio transformers, used for quality reasons in other days, often were of a type contributing to an overall gain of only 400 (which includes the amplification provided by the two tubes). No other power tube compares with the pentode for gain. For instance, the 245 tube has a mu factor of 3.5. Thus the pentode provides a volume of sound about 26 times that provided by the 245 for equal input voltage.

#### Fixing Up the Tuning

If you have tuning condensers that do not tune low enough in wavelength with particular coils you have, but go too high, you may remove turns from the secondaries until the tuning is correct. In manufactured coils this means work that one may not care to do, if there is some other way out, as the coil may be injured in the repair. If the coils were for 0.00035 mfd. it is clear that the condenser's capacity is too high, and probably it is of a special

(Continued on next page)

## the Midget Receiver

switch and volume control. Before placing the inside panel and chassis within the cabinet, the tubes are put in place and the set is tested out and equalizing condensers (4A) and (12A) are adjusted. After panel and chassis are placed in the cabinet, the three control knobs are put on from the outside.

The 0.0001 mfd. plate bypass condenser, not shown in the layout, but included in the schematic, may be placed anywhere inside.

[Other Illustration on Front Cover]



# The Economical Converter

[See article on preceding page]

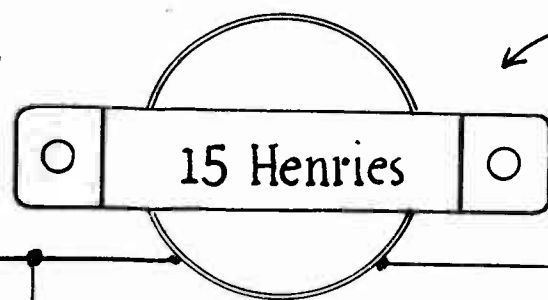

'B' SUPPLY CHOKE  
UNDER SOCKETS.  
ELEVATED BY  
BUSHINGS

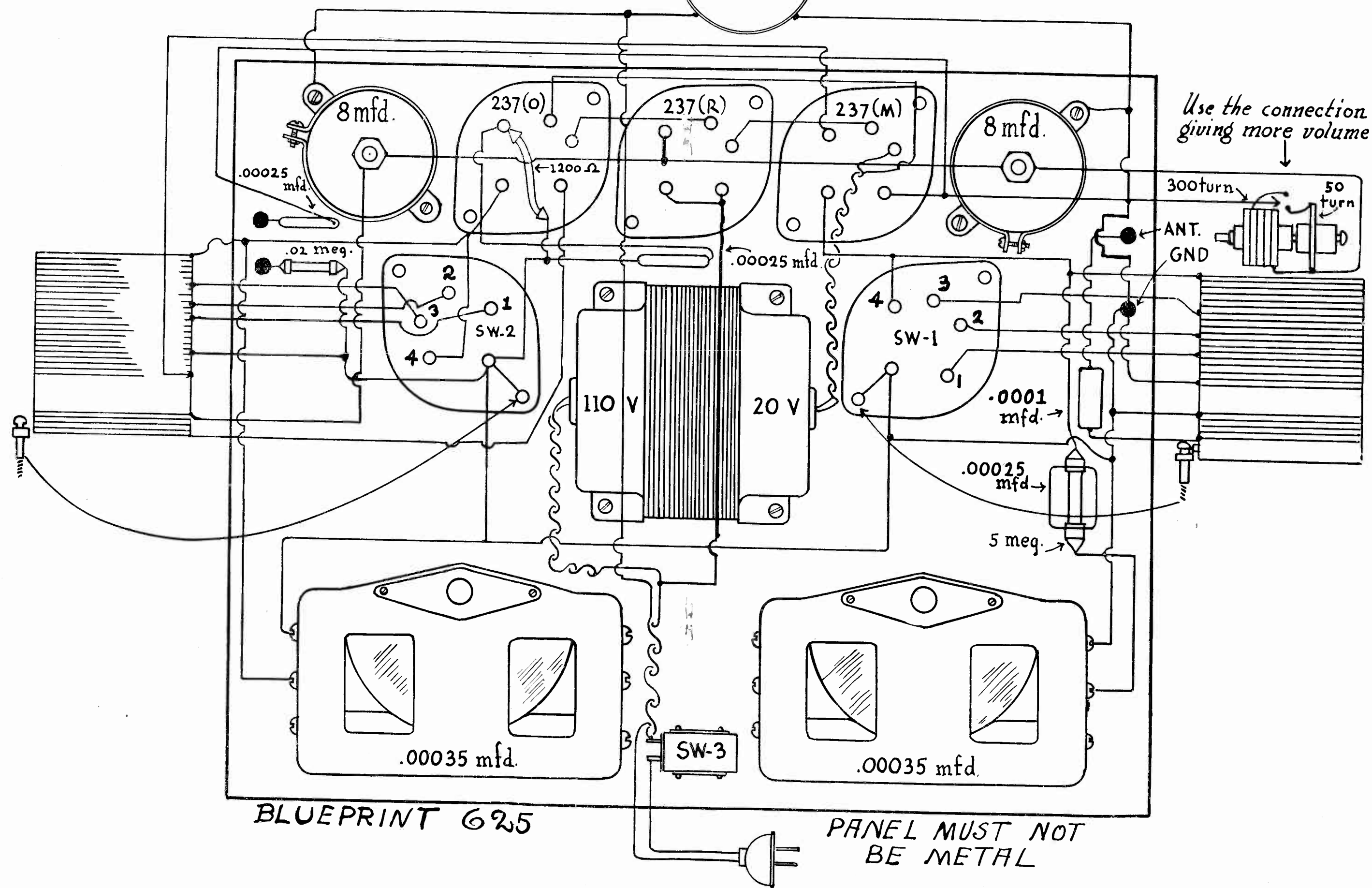

BLUEPRINT 625



# ed Radio Frequency Sets

## Remedy for A-C Sets—Other Solutions

Bernard

there is rectification there is a considerable drop in amplification, even though it is true that nearly all detector tubes in modern circuits amplify. The fact that they may be made to regenerate proves that they amplify.

Perhaps the easiest method to use is that involving the introduction of grid suppressors. These are placed between the grid of a radio frequency amplifying tube and the juncture of the tuning condensers, stator and terminal of the secondary.

Since the first radio frequency stage commonly will oscillate most, the value of the grid suppressor may be higher here than in subsequent stages. What the value should be can not be stated without knowing all the conditions, but it is indeed easy enough to put a resistor in the first stage that will considerably reduce the oscillation, then use a smaller value resistor in the next stage (if there are more than one r-f stage), and a still smaller one in the third stage (if there are three stages of r-f) until the oscillation stops.

The values used in commercial sets seldom, if ever, exceed 3,000 ohms, and in some instance this same value is used throughout. But in other instances as low as 200 or 300 ohms are used, or staggered values. One possible fault with this method is that A-C sets subject to a little hum may hum more, due to the ripple voltage drop in the suppressor.

### Low Frequency Effect

Another drawback of the system may be that when the highest frequency is stabilized the amplification is dropped too much for purposes of the lower frequencies, that is, volume is too low at the lower frequencies. The same can be said about the neutrodyne method of getting rid of oscillation, for all who have operated neutrodynes must be familiar with the great disproportion of sensitivity on the low as compared to the high frequencies of radio transmission (audio frequencies are not meant).

None of the neutrodyne methods, neither grid suppression of oscillation, nor the Rice method of plate neutralization (held by the courts to be tantamount to the other), is considered as virtual rebuilding of the tuner would be required.

However, when ever for any reason you run into too low amplification at the low frequencies, you may adopt the choke coil primary method already discussed. If the choke does not exactly fit inside the other form, because that form's diameter is too large, the choke may be held in place, magnetically parallel with the secondary winding, by a right angle bracket, attached to the large coil form, a long machine screw being put through the core of the choke coil and fastened with a nut to the bracket.

The metal in the field is no detriment to the present purpose, first, because the effect is slight, and second because we are engaged on problems that are well served by a little extra radio frequency resistance.

### Increased Negative Bias

Oscillation is conclusive proof the resistance has become negative.

It must be remembered that sets that don't work well will be made to work well, so paper losses will turn out to be operating profits.

Increasing the negative bias will help, too. If the tube is a 222, 224, or 232 or 236 (the 236 is the screen grid tube of the automotive series), then the negative bias method is not attractive, since detection starts too soon after the bias recommended for amplification is exceeded. But with the variable mu tubes, the 235 and the 551, the increased negative bias method works out very well.

The variable mu tubes, also called exponential tubes because their characteristic curves somewhat resemble an exponential curve, amplify well over a large variation of negative bias, even from 1.5 volts to as high as 10 volts or more, with somewhat more rapid decline in sensitivity thereafter, up to a usual limit of 25 or 30 volts, although reduction even to 45 volts on high-gain sets is not excessive.

### Tubes for Detection

The variable mu tube does not require any circuit changes except that the volume control vary the negative bias. The screen voltage may be varied instead of the grid bias directly, for that also varies the negative bias. As the screen voltage (if lower than the plate voltage to start with) is increased, the plate current is increased, along with the screen current, and as both of these flow through a biasing resistor, even if it is a fixed resistor or the bias increases as the volume control is moved toward full-on position. However, the variation is less than by the rheostat method. Usually the range is from 1.5 volts to around 10 volts, rather than from 1.5 volts to 25 or 30 or even higher. The 1.5 volt minimum may be exceeded, as explained, for stability without fear of stray distortion.

Some rheostats and potentiometers for volume control of multi-mu

tube sets have the fixed element built in. A good value for the total is around 3,000 ohms for an average t-r-f set, say, two stages of tuned amplification and tuned detector. But for a very high gain set the volume control may have a higher resistance value, both as to total and to fixed maximum. Of course, the fixed minimum may be supplied externally.

Therefore, if the receiver squeals, and it is an a-c set, consider the desirability of using the new multi-mu tubes, only in the radio amplifiers, however, not as detector, as the 224 will give more volume as a grid leak detector, with resistance coupling, so will the 227 if the first audio stage is transformer coupled.

The fixed element of the biasing adjunct therefore in increased in value until the squealing stops, but if the intensity of the squeals is terrific, it is obvious that a combination of remedies should be applied, including all or some of those already discussed, and certainly including reduction of the number of turns on the primary of the first radio frequency coupler.

### The Plate Primary Considered

The primary may be reduced very considerably, if it is wound directly over the secondary, as in many commercial coils. Close coupling of the two windings encourages this reduction. In fact, the location of the winding has just as much to do with the degree of coupling as has the number of turns on the primary. Therefore, with primary wound over secondary, it is often permissible to load even a screen grid tube with relative small number of turns, for instance, 30 turns if the diameter is 1 inch, 20 turns if it is 1.5 inch, 15 turns if it is 1.75 inch and 10 turns if it is 2 inches or more.

If, however, the primary joins the secondary, the two windings being side by side instead of one atop the other, then the turns removed may be fewer if taken off nearer the secondary, for the distance then between the two windings is being reduced with every turn removed, while if the turns are taken from the extreme end, farthest removed from secondary, the reduction in coupling is far less rapid per turn removed, and more turns should be taken off. No absolute numerical values can be given, but if squealing is bad, do not be afraid to remove half the number of turns from a primary wound over a secondary or one-quarter the turns from the far end, farthest from secondary, if they are wound side by side.

### Fewer Turns, Greater Volume

As has been stated, volume goes down, distortion goes up, when overloading takes place, therefore when you avoid oscillation overloads you will find that with fewer primary turns the volume is greater. If the primary has a number of turns approximately the same as the secondary, if the one winding is over the other, cut down the primary to one-fifth the number of secondary turns, and if they are side by side, make the ratio 1-to-4 without increasing the separation between windings.

Some stability may be gained by using an r-f choke coil in series with the primary in the plate circuit, as diagrammed, and also one in series with the screen, the value of the chokes not being critical, anything from 1 millihenry up (the 300-turn honeycomb is about 1.3 millihenry) being satisfactory, and the condenser from one side of choke to ground being 0.006 mfd. up, no matter how high. This system helps to keep the radio frequencies out of the power supply and resistor adjuncts, and, in the case of a battery set, out of the B batteries, but it is simply an additional method, not to be relied on exclusively for curing any bad cases of squealing, but always may be introduced in addition to other methods.

Of these other methods, if an a-c set is to be remedied, the minimum bias method, using variable mu tubes, is as good as any, while the turns-off proposal helps a great deal, and the two may be used conjunctively.

### Concentration on Detector

If a leak-condenser detector is used, squealing may be reduced considerably by reducing the value either of the grid leak or the grid condenser or of both. This, of course, reduces the sensitivity. If the leak value is reduced to, say, 0.1 meg., then the plate return may be made to a much higher voltage. For resistance audio the applied voltage to the resistor in the plate circuit (not shown) may be 180 volts. Then you have a case of semi-power detection with leak-condenser.

If a screen grid tube is used as detector the screen may be returned to a lower voltage than at present, and it is also advisable to put a resistor in series with the screen to this lower voltage, say, 0.1 meg. A condenser across this resistor may be 0.01 mfd. or higher. If the condenser is omitted from this position the damping may be great enough to stop oscillation without resort to any other means. In fact, in many cases only the detector need be re-

(Continued on next page)

# Coil Windi Various Shape Factors Co

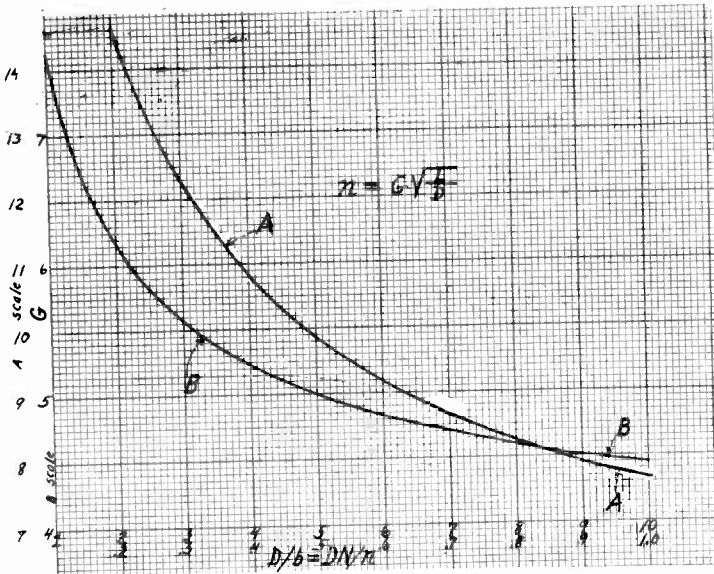

FIG. 1

A curve that may be used in computing the inductance and turns of coil of the single layer solenoid type. The curve is plotted in two sections, A and B, to different scales. A pertains to the larger scale on the left and the smaller scale at the bottom. B pertains to the smaller scale on the left and the larger at the bottom.

IN the preceding issue (August 22d) we gave a formula for computing the number of turns required to give a desired inductance when the diameter of the form was given, but the formula applied to the case when the ratio of the diameter to the length of the winding was 20/9, or when the shape factor was near optimum. In this formula the coefficient of the square root of the ratio of L to D was 6. A coil of just this shape is not always convenient and the formula should be made available for all the shape factors that are likely to be met in practice.

The best way to make it available for a large number of values, and for any value between certain limits, is to plot a curve of the coefficient. Such a curve is given in Fig. 1. The curve is plotted in two parts, one covering the range of D/b from 0.2 to 1.0 and the other from 1.0 to 10. That is, the total range of the curve is from 0.2 to 10 for the ratio of the diameter to the axial length of the winding. This covers all coils that are likely to be used in a radio receiver. Of course, the curve is only applicable to single layer solenoids.

### Derivation of Coefficient

The coefficient has been designated by the letter G and it is the square root of  $(40b/DK)$ , that is,  $G = (40b/DK)^{1/2}$ , in which b is the axial length of the winding and D the diameter of the form. The units in which D and b are measured may be inches or centimeters because only the ratio matters. The ratio D/b is the abscissa in the curve of Fig. 1 and it is one of the known factors about the coil to be wound. This ratio is also equal to DN/n, in which D is the diameter and N is the number of turns per unit of length. If D is measured in inches then N is the number of turns per inch and if D is measured in centimeters N should be the number of turns per centimeter. The ordinates of the curve in Fig. 1 give the values of G for any value of D/b.

When the value of G has been found from the curve the number of turns required to give an inductance of L microhenries on a diameter of D inches is  $n = G(L/D)^{1/2}$ . In this formula only microhenries and inches will give the correct results.

### Applying the Formula and Curves

The use of the formula and the curve can be made clear by a few examples. Suppose we wish to make a coil having an inductance of 200 microhenries on a form 2 inches in diameter. Let us further suppose that the ratio D/b is to be 0.3. The A section of the curve in Fig. 1 applies and this curve is plotted to the lower scale of abscissas and the left scale of ordinates. We find the value of G to be 12.3. Then we have for the turns  $n = 12.3(200/2)^{1/2}$ , or 123 turns. Now we have to determine the size of wire to use. Since the diameter is 2 inches and D/b is 0.3, the axial length of the winding must be 20/3 inches. Hence the wire should wind 18.45 turns to the inch, either by spacing the turns or by selecting suitably heavy wire.

Again, suppose we wish to wind a coil of the same inductance on the same form but with a shape factor determined by D/b=1. The corresponding value of G we find on either curve to be 7.625. Hence  $n = 7.625(200/2)^{1/2}$ , or 76.25 turns. The winding now is 2 inches long, since the length is equal to the diameter. Hence we must use wire that windings 76.25/2, or 38.125 turns to the inch, or if finer wire is used, space the turns so that the length is 2 inches.

### Other Examples

Let us try smaller coils. Suppose we have a form 1.25 inches in diameter and we wish to wind a coil having an inductance of 50 microhenries with a shape factor equal to 5. We find G on section B of the curve over D/b=5 to be 5. Hence  $n = 5(50/(1.25)^2)^{1/2}$ , or 31.8 turns.

In this coil the length of the winding is only 0.25 inch and in this space we must crowd 31.8 turns. Therefore the wire used must wind 127.2 turns to the inch. We might conclude that the coil is not practical since the necessary wire is too fine for a tuning coil. However, whether or not it is practical depends on the use to which the coil is to be put.

Let us try another combination for this coil. Let us assume that the shape factor is 2. We find the value of G on section B of the curve over 2 on axis of abscissas, and it is 6.17. Hence  $n = 6.17(50/(1.25)^2)^{1/2}$ , or 39 turns. More turns are now needed because the coil is longer. The length of the winding is now 0.625 inch and therefore the wire to be used should wind 62.4 turns to the inch. This coil is near that which gives the optimum shape, which would call for 37.9 turns in a space 0.5625 inches. This would call for wire that winds 67.3 turns to the inch.

### Still More Examples

Let us now assume that we want a coil having an inductance of only 4 microhenries, using a diameter of 1.25 inches and a shape factor of 8. G for this case is 4.595 and  $n = 4.595(4/(1.25)^2)^{1/2}$ ,  $n = 8.23$  turns. The wire used must wind 52.7 turns to the inch, for the length of the winding is only 5/32 inch.

It is now common practice to wind broadcast coils on tubing one inch in diameter. These coils, as a rule, are longer than the diameter. In fact some of them are two inches long while others are 1.5 inches. Let us first determine the number of turns required to wind a coil having an inductance of 240 microhenries, for a 0.00035 mfd. condenser, on a one inch diameter and 2 inches long. In this case D/b is 0.5 and the corresponding G is 9.875. Hence  $n = 9.875(240/1)^{1/2}$ , or 153 turns. Since the winding is 2 inches long the wire used must wind 76.5 turns to the inch.

Next let us determine n for a coil 160 microhenries, for a 0.0005 mfd. tuning condenser, using the one inch diameter and 1.5 inches length. Then D/b is 2/3 for which G is 8.8. Hence  $n = 8.8(160/1)^{1/2}$ , or 111.4 turns. Hence the wire used must wind 74.25 turns to the inch, since the length is 1.5 inches.

### Very Small Coils

The formula and the curve apply to extremely small coils as well as to larger. Suppose, for example, that we wish to make a coil having an inductance of one microhenry, winding the turns on a form 0.25 inch in diameter. Let us assume that the length of the winding is equal to the diameter. Then D/b equals one. For this case the value of G is 7.625. Hence the value of n is  $7.625(1/(0.25)^2)^{1/2}$ , the inductance being unity and the diameter 0.25 inch. That is, n equals 15.25 turns. Since these turns must occupy 0.25 inch the turns per inch must be 61 turns.

## Shielded Coils Often Couple

(Continued from preceding page)

tarded, and squealing will stop, since it is an overall condition that frequently causes the trouble, and if one stage, any one, is sufficiently damped the remedy may be complete. If the damping is too great the remedy may be worse than the ailment.

Any set that squeals badly and is not shielded certainly should be shielded. However, when you put a shield on a coil you need many more turns of wire for equal inductance, as the shield reduces the inductance. For example, to tune in the broadcast band with a coil of 1.7 inches winding diameter, for .00035 mfd. condenser, using No. 28 enameled wire, 76 turns are needed when no shield is used, but with a shield (1/64 inch aluminum, 3 inch diameter, 3 1/2 inches high) the number of turns required is 90, quite a difference!

### Coupling Despite Shields

All shields should be grounded.

There can be coupling even between shielded coils, since the leads may couple, besides the coils themselves, so mere shielding is no guarantee there will be no squeals. All the recommendations already made apply to curative work done on shielded sets that squealed.

Many times the squealing is so great and the results so abominable that after repeated efforts little if any progress is made, and

# ing Formula nsidered for Application

We can also use the formula for determining the inductance if we know the diameter, the number of turns, and the size of wire. For this computation it is convenient to write the formula appearing on Fig. 1 in the form  $L=D(n/G)^2$ . Let us suppose we have a coil of 15 turns wound with No. 24 double cotton covered wire on a form one inch in diameter. We first have to look up the number of turns per inch for No. 24 double cotton covered wire. On the front cover of the Aug 22 issue, last week, we find that  $N=34.4$ . We know that  $D/b=DN/n$  Hence  $D/b=1 \times 34.4/15$ , or 2.294. We find the corresponding value of G on Fig. 1. It is 5.95. Therefore  $L=1 \times (15/5.95)^2$ , 6.35 microhenries.

### Inductance Computation

Let us take another example of inductance computation from known data. Suppose we have a coil wound on a diameter of 1.75 inches with 75 turns of No. 28 enameled wire. What is the inductance? From the table of wire data published last week we find that No. 28 enameled wire winds 74.1 turns to the inch. Since there are 75 turns in the coil the length of the winding is 75/74.1, or 1.011 inches long. Therefore  $D/b$  is 1.75/1.011, or 1.73. The value of G for this we find from Fig. 1 to be 6.425. Hence the inductance is  $1.75 (75/6.425)^2$ , or 238.5 microhenries.

Again, suppose we have a coil of 50 turns of No. 26 double silk covered wire wound on a form 2.5 inches in diameter. What is the inductance? This wire winds 50.5 turns to the inch. Hence the length of the winding is 0.99 inch. The ratio  $D/b$  is therefore 2.53, for which G is 5.8, which is obtained from B, Fig. 1. Therefore the inductance is  $2.5 \times (50/5.8)^2$ , or 186 microhenries.

There is still another useful application of the formula and the curves. Suppose we wish to wind a coil of a certain inductance with a certain number of turns to a given shape factor. What diameter should be used? This might be used as a preliminary computation in case we have several sizes of tubing available. To solve this problem we can write the formula in the form  $D=L(G/n)^2$ .

Let the inductance be 160 microhenries, the turns 56, and the shape factor of 2. We first have to find G, and to find it we have to make use of the known shape factor, namely 2. From Fig. 1 we find G to be 6.17. Hence the diameter is  $160 (6.17/56)^2$ , which is 1.94 inches. The nearest is 2 inches, which would be selected.

### Not Practical

This particular application is not very practical for there is no particular reason why we should use just 56 turns on the coil. But suppose we know the turns per inch instead, which we do as soon as we have decided what wire to use. Let the wire be No. 28 enameled, which winds 74.1 turns to the inch. In this case we can use the formula  $D^3=4L(G/N)^2$ . Now we know that the shape factor is 2 and therefore that G is 6.17. We also know that N is 74.1 and that L is 160. Therefore the cube of the diameter required is 4.43, the cube root of which is 1.641 inches. The nearest standard tube diameter is 1.75 inches.

If we use a diameter of 1.75 inches and wish to make a coil of 160 microhenries with No. 28 enameled wire, we have to use the cut and try method of finding n explained last week.

### TURNS PER LINEAR INCH

B. & S. Gauge	cc. Ohms per 1,000 Feet	TURNS PER LINEAR INCH										
		Single Silk	Double Silk	Single Cotton	Double Cotton	Enameled	Enameled SS	Enameled DS	Enameled SC	Enameled DC		
14	2.525											
15	3.184	16.9	16.3	15.6	13.6	15.2					14.1	13.3
16	4.016	18.9	18.2	17.9	16.7	19.1	18.4	17.7			15.6	14.8
17	5.064	21.2	20.3	19.9	18.2	21.5	20.5	19.7			17.4	16.3
18	6.385	23.6	22.6	22.1	20.2	23.9	22.8	21.8			19.3	17.9
19	8.051	26.3	25.1	24.4	22.2	26.8	25.4	24.2			21.4	19.7
20	10.15	29.4	27.8	27.0	24.3	30.1	28.4	26.9			23.6	21.5
21	12.80	32.7	30.8	29.8	26.7	33.7	31.6	29.8			26.1	23.6
22	16.14	36.6	34.2	33.0	29.2	37.7	35.0	32.8			28.9	25.9
23	20.36	40.6	37.7	36.2	31.6	42.3	39.0	36.4			31.7	28.1
24	25.67	45.2	41.6	39.8	34.4	47.1	43.1	39.8			34.9	30.6
25	32.37	50.2	45.8	43.6	37.2	52.9	47.8	43.8			38.1	33.1
26	40.81	55.8	50.5	47.8	40.1	59.1	52.9	48.0			42.8	35.8
27	51.47	61.7	65.5	52.0	43.1	66.2	58.4	52.9			45.7	38.6
28	64.90	68.4	60.9	56.8	46.2	74.1	64.5	57.8			49.7	41.4
29	81.83	75.1	67.1	61.3	49.2	83.3	71.4	64.1			54.0	44.4
30	103.20	83.1	79.2	66.5	52.5	92.2	77.8	69.2			58.8	47.6
31	130.10	91.5	79.3	71.9	55.8	103.4	85.6	75.3			63.0	50.3
32	164.10	100.5	86.5	77.2	58.9	115.6	93.8	81.6			68.1	53.5
33	206.90	110.1	93.6	82.8	62.1	129.3	102.7	88.2			73.2	56.6
34	260.90	120.4	101.0	88.4	65.3	144.9	112.3	95.2			78.5	59.7
35	329.00	131.4	108.5	94.3	68.4	162.3	122.5	102.4			84.0	62.8
36	418.80	142.8	116.2	100.0	71.4	181.8	133.3	109.8			89.6	65.9
37	523.10	155.0	124.2	105.8	74.3	202.4	144.1	117.1			95.2	68.9
38	659.60	167.7	132.2	111.6	77.1	227.7	156.4	125.1			100.6	71.7
39	831.80	180.5	140.2	117.2	79.8	255.5	167.7	132.2			106.4	74.6
40	1,049.00	194.5	148.3	122.8	82.3	280.1	179.5	139.4			111.6	77.1
											116.6	79.5

The formula in Fig. 1 gives a relationship among four different quantities, and if we know any three of them we can find the fourth. Since the curve in Fig. 1 gives G for different values of  $D/b$ , the length b of the winding can also be found whenever G can be found. For example, suppose the coil has 50 turns, a diameter of 1.75 inches, and an inductance of 160 microhenries. Solving the formula in Fig. 1 for G we find  $G=5.225$ . On curve B we find that this value of G corresponds with a value of 4 for  $D/b$ . Since the value of D is known to be 1.75 inches, the value of b is 0.4375 inches. There are 50 turns in the coil and therefore N must be about 114 turns.

### Cut and Try

This suggests a method of cut and try for determining the proper number of turns when the turns per inch are known, using the curve for G. The method is to assume values for n and from this compute the value of N. The process is continued until the computed value of N is the same as the tabular value of N for the particular wire used. Let us try it.

Our problem is to wind a coil of 160 microhenries on a 1.75 inch diameter with No. 28 enameled wire, for which N is 74.1. How many turns are required? The formula in Fig. 1 becomes  $n=9.56G$ .

n	G	D/b	N	Comment
50	5.225	4	114	This was a wild guess.
60	6.275	1.88	64.4	We have already overshoot the mark.
58	6.07	2.13	70.6	We are now very close.
57	5.96	2.29	74.5	Still closer.
57.1	5.97	2.28	74.3	And still closer.
57.2	5.98	2.27	74.1	Exact.

The exactness of this determination is no greater than the accuracy of the reading of the curve. It is quite possible that 57.1 is just as close as 57.2 turns. As a matter of fact, it is close enough to call it 57 turns, because a fractional turn has little significance in winding a coil.

However, let us check back, using 57.2 turns. The inductance turns out to be 161.1 microhenries. If we use 57.1 turns the inductance turns out to be 160.6. If we use 57 turns the inductance computes into 160.3. Therefore a few tenths of turns make little practical difference.—J. E. Anderson.

## Strongly to One Another

one would be prompted to consign the whole set to the scrap heap. However, don't do it, for the trouble can be cured, and if some of the suggested remedies applied, then you can be certain that you will get the set into operating condition.

One of the hardest things of which to convince the worker is that the number of turns of primaries in screen grid tube plate circuits may be reduced to a relative few, say 10 turns or so. It is the degree of coupling that is important, and no fear need be felt in reducing turns to that point where the coupling does not exceed that required for stable operation. The difference is usually that between operation and non-operation, and there is no use adhering to a theory that leads to no results, when a practical method of attaining excellent results is readily at hand.

### Squealing at Low R-F

A situation sometimes obtaining is that of squealing at low radio frequencies, none at high. Reline the set, adjusting trimmers for a high frequency (1,300 kc or so). If squealing results at high frequencies now, apply previously cited remedies.

If the squealing is retained only at the low frequencies, there is too much r-f resistance in the circuit, for it is more effective on the highs (hence no squealing there) and less so at the lows. The remedy is to use better coils or larger shields.

## RADIO WORLD

### ADVERTISING RATES

	4 consec.		13 consec.		26 consec.		52 consec.	
	Inser. (ea.)	Inser. (ea.)	Inser. (ea.)	Inser. (ea.)	Inser. (ea.)	Inser. (ea.)	Inser. (ea.)	Inser. (ea.)
1 page	10%	12 1/2%	15%	20%				
1/2 page	\$150.00	\$135.00	\$131.25	\$127.50	\$120.00			
1/4 page	75.00	67.50	65.62	63.75	60.00			
1/8 page	50.00	45.00	43.75	42.50	40.00			
1/16 page	37.50	33.75	32.81	31.87	30.00			
1/32 page	25.00	22.50	21.87	21.25	20.00			
1/64 page	18.75	16.87	16.41	15.94	15.00			
1 inch	5.00	4.50	4.37	4.25	4.00			

Classified advertisements, 7 cents a word; \$1.00 minimum; must be paid in advance.

### Advertising Department

Radio World, 145 West 45th St., New York, N. Y.

**A Question and Answer Department conducted by Radio World's Technical Staff. Only Questions sent in by University Club Members are answered. Answers printed herewith have been mailed to University Members.**

# Radio University

To obtain a membership in Radio World's University Club for one year, send \$6 for one year's subscription (52 issues of Radio World) and you will get a University number. Put this number at top of letter (not envelope) containing questions. Address, Radio World, 145 West 45th Street, New York, N. Y.

Annual subscriptions are accepted at \$6 for 52 numbers, with the privilege of obtaining answers to radio questions for the period of the subscription, but not if any other premium is obtained with the subscription.

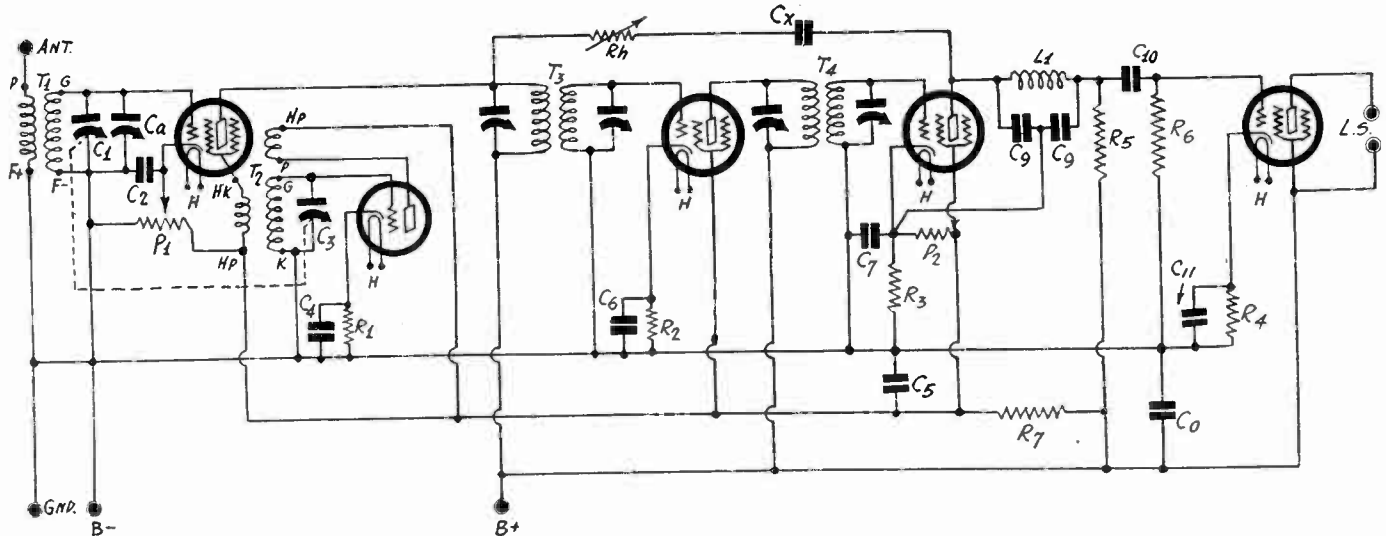

FIG. 946

Regeneration can be used in the intermediate frequency amplifier when it is necessary to get high sensitivity out of a receiver with only a small number of tubes.

### Regenerative Superheterodyne

**I**F you think it practical to build a superheterodyne with regeneration in the intermediate amplifier, will you kindly publish a circuit of this. I should like, if possible, to build a super with only five tubes.—B. W.

In Fig. 945 is the diagram of such a circuit. It is published for what it is worth. In order to make the regenerative feature a success the intermediate frequency should be high, preferably of the order of 450 kc, but it is quite possible to use 175 kc. For simplicity the two tuners, the r-f and the oscillator, should be controlled by two independent condensers. The various values may be as follows: T1, a regular radio frequency transformer with a small primary and a secondary wound for a 0.0005 mfd. condenser; T2, an oscillator coil the main winding of which is for a 0.0005 mfd. condenser, the tickler 2/3 as many turns as the tuned winding and the picking winding from 5 to 10 turns; T3 and T4, two intermediate frequency tuned transformers; L1, one 10 mh. choke coil; C1, C3, two 0.0005 mfd. tuning condensers; Ca, a trimmer condenser; C2, C4, C6, 0.1 mfd. condensers; C5, C7, C9, three 2 mfd. condensers; C11, one 4 mid. condenser; Cx, a small fixed condenser about 100 mmfd.; C9, two 0.00025 mfd. condensers; C10, one 0.01 mfd. condenser; P1, one 25,000 ohm potentiometer; Rh, one 25,000 ohm variable resistance; R1, 1,500 ohms; R2, 300 ohms; R3, 3,000 ohms; P2, omit; R4, 1,500 ohms; R5, 250,000 ohms; R6, one megohm; R7, 10,000 ohms. The tubes needed are three 236s, one 238, and one 237.

### Design of Portable Receiver

**I**AM looking for a portable receiver for battery operation. It must be capable of operating a loudspeaker and be reasonably sensitive so that I can get reliable reception 100 miles from high power stations. A good antenna and ground system can be provided. Will you kindly publish such a circuit, or refer me to a circuit of this type that has been described recently?—E. W. B.

There is such a circuit described on Page 11, Aug. 22, 1931 issue. While the circuit is described as a short wave set, it is only necessary to select appropriate tuning coils and condensers to make it a broadcast set.

### Problem of Instability

**I**HAVE been trying to build a very sensitive and high quality audio frequency amplifier, but I have run against instability trouble. I need about 5 stages, but so far I have not even been able to use four stages without getting an oscillator. Can you suggest what to do?—G. J.

Eliminate the cause of the instability. The cause is the common impedance among the plate circuits. About the only remedy for the instability is to use separate B supplies for the different tubes. If you have four stages you should use at least two different B supplies, each of which may be a B battery eliminator. If you are to use 5 or 6 stages you should

use three different B supplies. By-passing is usually ineffective at low frequencies where most of the instability occurs. If you use a fully charged storage battery for the B supply it may be possible to use 5 stages on the same battery because the internal resistance of the storage battery is low.

### Variations of High Resistance Wire

**D**OES resistance wire vary with frequency in the same manner as copper wire or does it remain constant? What can be done about making resistances that will have the same value at radio frequencies as at low frequencies?—W. J. L.

Resistance wire varies in the same manner as copper wire, but not in the same degree. The higher the specific resistance of a wire the less is the frequency variation of the resistance. Iron and steel do not follow the rule because of the higher permeability. Any high permeability metal varies more than metals having unit permeability. The resistance of nickel wire varies considerably with frequency because it has a high permeability. Resistances for high frequencies should be made of alloys having a high specific resistance, a low permeability (unity), and a low temperature coefficient of resistance. Manganin and similar alloys meet the requirements best. Not only should a suitable material be chosen for the wire but the wire should be wound so that the coil has neither distributed capacity nor self-inductance. Whatever material is chosen, the wire should be fine for the resistance does not vary nearly so much with frequency when the wire is fine as when it is heavy. In this respect the current carrying capacity of the wire must also be taken into account.

### Rewinding a Filament Transformer

**I**WANT a filament transformer for the 6.3 volt tubes but I have not succeeded in finding one. I have a number of transformers giving 2.5 and 5 volts across the secondaries. Is there any way in which I can rewind these so that I will get the 6.3 volts? Will I have to change both the primary and the secondary windings? If the change is practical will you kindly tell how many turns to use?—R. B. N.

If the secondary winding on a filament transformer is on the outside of the primary, which is the case in nearly all cases, the change is very simple. Remove the secondary winding, counting the turns. Do not touch the primary winding. After having removed the secondary winding put on another winding, determining the number of turns on the basis that the voltage is directly proportional to the number of turns. For example, if you remove a 2.5 volt winding and find that it has 20 turns you know that there is 2.5/20 volt per turn. Now if you want to get a voltage of 6.3 volts you have to put on  $6.3 \times 20 / 2.5$  turns, or 50.4 turns. If N1 is the number of turns removed and V1 the voltage of the winding before removing, and if N2 is the turns required to give a voltage V2, then  $N1/N2 = V1/V2$ ,  $N2 = N1N2/V1$ , may be used in any case for determining the number of turns needed, provided the primary



winding is not touched. The size of wire to use on the new winding depends on the current that it is expected to deliver. The rule usually employed is to allow one circular mill for each milliamper, or a little heavier wire than this rule gives. Sometimes they allow 1.5 circular mill for each milliamper, especially when the ventilation of the transformer is not good. The circular mills in any wire can be obtained from wire data tables. If the 6.3 volt winding is to serve 5 automotive type tubes the current will be 1.5 amperes, and the wire should have 1,500 circular mills, or more. The nearest is No. 8 B. & S. wire. In cheap transformers much finer wire would be used, for in making them the rule is not followed.

**Channel Width for Television**

**H**OW wide a channel is needed for television signals based on 400 lines to the frame and 24 frames per second? Would it be practical to use as fine "screen" as this? —E. S.

If 400 lines per frame is not practical it is not because there are too many lines, but rather because there are not enough. And it is quite possible that 400 lines are too many to be practical for mechanical reasons as well as for channel-space reasons. The channel space required for 400-line, 24-frame television, or any other, is not a definite value. If we base our estimate on the usual assumption, which is entirely artificial as well as faulty, that 400-line scanning is equivalent to 400-line half-tone screen, then we should have 400x400x24 as the high frequency limit. This is 3,840,000 cycles per second, or more than four times as wide a band as the entire broadcast band. And at that, it allows for only one side band and nothing at all for the higher harmonics which must be present. But as stated, the half-tone basis of figuring is incorrect. Nearly every picture changes from light to shade gradually rather than from nothing to something 400 times in a line across it. Let us say that the change occurs five times, or its equivalent, from highlight to deep shadow. On that basis we should get a good picture by using the number 400x5x24, or 48,000. That is not so bad and comes within the band allowed for television at this time, namely 100,000 cycles, leaving room for both sidebands. This five-time variation does not allow for any harmonics which arise at places where the density of the object changes rapidly and there would be some blurring. A black line, for example, would become a gray band.

**The Pendulum Swings Back**

**A** FEW years ago the average circuit consisted of four tubes, and most circuits at that time were very sensitive. Then came the era of multi-tube circuits, some sets having as many as twelve tubes for amplification and detection. Now the pendulum is swinging back to fewer tubes, and the modern modest sets are sensitive too. Now what is the reason the multitube sets are not proportionately sensitive and why are the sets with few tubes so sensitive?—E. E. C.

When only a small number of tubes is used each tube and each tuner is made to perform in the best possible way. When multitube sets are used tubes and tuners are made relatively insensitive. The type of set on the market follows the public demand. At this time most people want inexpensive sets and the midget is the answer. The small size and sensitivity have been made possible by the introduction of new and more sensitive tubes. Screen grid tubes and pentodes have done a great deal to reduce the number of tubes needed for a given sensitivity.

**About Power Rating of Resistors**

**R**ECENTLY I asked a radio engineer the following question: How many ohms will I need to cut down the voltage 50 volts when the current is 5 milliamperes? The reply was 10,000 ohms. I got a 10,000 ohm resistor and put it in the circuit. It lasted about five minutes and then burned out. If a radio engineer cannot give the correct values, who can? —G. N. W.

The engineer gave you the right answer. He gave you no more and no less. Apparently, you did not ask enough, for you should also have asked about the necessary power rating of the resistance. The power dissipated in the 10,000 ohm resistance when the current is 5 milliamperes is 0.25 watt. It seems that almost any 10,000 ohm resistance should stand up under that. But to play safe it is customary to allow a large safety factor. The specified rating should have been at least one watt, preferably 5 watts. It may well be that the resistance you got had that rating and that it actually could carry 20 to 25 milliamperes without overheating. But are you sure that the circuit was such that no more current flowed through it, that is, are you sure that while the resistance was heating up the voltage was not many times to 50 volts?

**Insensitivity of Auto Receivers**

**I** HAVE tried many automobile receivers with uniformly poor results. They do not bring in signals satisfactorily. Yet the same receivers are sensitive when I try them out in my home or in a radio store. The trouble is not with the receivers so it must be the automobile. Will you kindly explain?—W. L. E.

The trouble is that you have neither ground nor antenna in

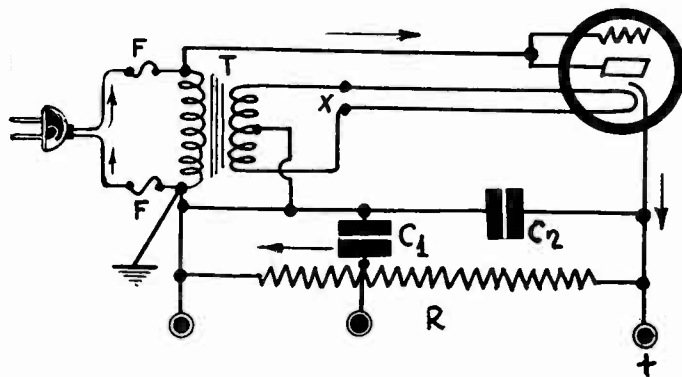

FIG. 947

The circuit of a simple rectifier, which is useful when a voltage of around 100 is desired and no great current is needed.

the car. There is no ground because the car chassis is insulated from the ground by the rubber tires and by the road itself. However, the car chassis acts as a counterpoise as a substitute for the ground. But the antenna is almost entirely lacking. A lot of wire strung around the car is not an antenna unless it projects outside the car, either above or on one side. Under the best conditions the pick-up of signals is very small. Therefore a much more sensitive set is needed in a car than in the home or in a radio store.

**Reception on Socket Antenna**

**I** USE a socket antenna for broadcast reception and get good results. But when I try to receive short waves the socket antenna does not work. A short wire antenna brings in lots of short wave signals on my short wave set so I know there is nothing wrong with the receiver. Why does not the socket antenna work on short waves?—A. B. N.

It must be that the distributed capacity between the high side of the socket antenna and ground is so great that the short wave signals are shunted out. Perhaps all you have to do is to take the socket antenna out of the socket and utilize the pickup of the lead ordinarily running from the antenna post to the socket in the wall. It is a good idea to lift up the plug as far as possible. Tiny capacities are very disturbing on short waves where they may often be neglected at broadcast waves.

**Simple Rectifier**

**W**ILL you kindly publish the circuit of a very simple rectifier using a 227 tube? I am not interested in the current that it will deliver but it should give about 100 volts.—F. W. C.

Fig. 947 gives a very simple circuit. C1 and C2 may be 4 mfd. condensers and R a 25,000 ohm resistance or voltage divider. This circuit is a half wave rectifier.

**Join**

**Radio World's**

**University Club**

And Get Free Question and Answer Service for the Coming 52 Weeks. This Service for University Subscribers Only. Subscribe for RADIO WORLD for one year (52 numbers).

Use the coupon below or write on a separate sheet of paper, if preferred. Your name will be entered on our subscription and University Club lists by special number and you will be apprised of the number. When sending questions, put this number on the outside of the forwarding envelope (not the enclosed return envelope) and also put it at the head of your query. If already a subscriber, send \$6 for renewal from close of present subscription and your name will be entered in Radio University.

**NO OTHER PREMIUM GIVEN WITH THIS OFFER**

[In sending in your queries to the University Department please paragraph and number them. Write on one side of sheet only. Always give your University Club Number.]

RADIO WORLD, 145 West 45th Street, New York City. Enclosed find \$6.00 for RADIO WORLD for one year (52 nos.) and also enter my name on the list of members of RADIO WORLD'S UNIVERSITY CLUB, which gives me free answers to radio queries for 52 ensuing weeks, and send me my number indicating membership.

Name .....

Street .....

City and State .....

## A THOUGHT FOR THE WEEK

**W**HATS happened to the army of astrologers that threatened to drive sane people away from their receiving sets? Station officials have seen a great light and now the American public will have to wag along without the aid of the ages-old rot that has been masquerading on the air as a "science."

# RADIO WORLD

The First and Only National Radio Weekly  
Tenth Year

Owned and published by Hennessy Radio Publications Corporation, 145 West 45th Street, New York, N. Y. Roland Burke Hennessy, president and treasurer, 145 West 45th Street, New York, N. Y.; M. B. Hennessy, vice-president, 145 West 45th Street, New York, N. Y.; Herman Bernard, secretary, 145 West 45th Street, New York, N. Y.  
Roland Burke Hennessy, editor; Herman Bernard, managing editor and business manager; J. E. Anderson, technical editor; L. C. Tobin, advertising manager.

## Kits for Midgets

**R**ADIO experimenters fortunately don't agree very well on controversial technical and merchandising subjects, so quite a few say they hope that the midget set craze will die out speedily, and radio thus will cease getting a black eye. A commentator in a periodical said that the midget set designers had caught up with the 1926 models.

But it is hard to present any argument strong enough to overcome a fact. And the fact is that the set-buying public is eager for midgets—the cheaper they are, the greater the eagerness. It may be thought that size has something to do with it, but if a console type were sold at less than the price of the midgets, then the consoles would reign, instead of being, as now, mere pretenders to the throne.

We believe that the demand for midgets should be filled without lament over difference in performance between a midget and a larger set. Nobody can stop the manufacturers from filling the demand. The strangeness of the situation lies, we think, in the presumption that anything like discouragement should be broached. Let's have midgets and midgets—the more, the merrier. Those who don't care for them should shout for midgets for the other fellow's sake.

Aside from manufactured sets, how about kits? There is hardly a midget kit on the market. Maybe the home constructors aren't interested—but we have a hunch they are. A five-tube kit (with two stages of tuned radio frequency, tuned detector, one stage of audio, with pentode output, and 280 rectifier) could be put out, less tubes, to sell net to the builder at around \$20, including of course the conventional Gothic cabinet and the dynamic speaker.

We hereby encourage kit producers to get busy with kits for midget sets, for we believe there is an excellent market here, and the constructors who desire midgets will have an assortment of manufacturers catering to their needs, instead of next to nobody, as now!

If you agree with us, why not write us to that effect? We will show the correspondence to kit and parts manufacturers, and virtually force them (by the lure of prospective business) to get busy.

## NATIONAL RADIO WEEK TO START SEPTEMBER 21st

National Radio Week will be held from September 21st to 27th, concurrent with the Radio-Electrical World's Fair at Madison Square Garden, New York.

## MARIANI'S SLEEVE GARTERS

Hugo Mariani is one of the few NBC orchestra leaders who wear sleeve garters.

# Forum

Come-ons His Pet Peeve

**I** AM one of the pioneers of radio, in 1901 having built, designed, constructed and erected one of the first commercial radio communications from Catalina Island and Los Angeles (San Pedro).

A nationally known engineer claimed this distinction several years ago in a story published in "Radio Broadcast" and I promptly forwarded proof that he was an imposter, but all I got was an apology and explanation of why it was better to let the mistake stand uncorrected.

I followed radio along with other electrical research work until about 1920 and am now commencing to catch up with what has taken place in the interim. My inspiration is occasioned by a small "ham," a boy about 14 years old who came into my laboratory the other day and talked radio 'way over my head, hence all this prelude to you as to why I am getting back into the game last.

I have copies before me of each of the last issues of all radio magazines and without any bias whatever hold yours superior and enclose check for subscription and membership to University Club.

My comment on radio publications is that when they describe the construction of a receiver, or what-not, they still cling to the "come-on" game of telling you about 80 per cent. enough and adroitly steering you to buy manufactured parts from their paid advertisers. I am plenty able to buy parts—but don't want to, as I get a kick out of "making my own," often better, as I have a complete shop and laboratory. For example, I have a coil winding machine for winding superheterodyne coils, honeycomb, to any specification as small as possible and with as fine as No. 40 wire, and have made intermediate frequency coils, matched and equal to any, and better than most I can buy.

I am now going into short wave reception and will build my own. Really, I think you will agree with me that it's the "ham" building his own who is the real developer of radio, rather than the manufacturer. The ham's interest is the fascination of exploring and keeping ahead of the times, instead of trailing the manufacturer who is always behind in the march of this fast-moving industry.

Why don't you publish a clear and concise, complete and thoroughly itemized and detailed description of the best short wave receiver that you know of, showing how to make all parts, stating, if need be, where they can be purchased? I have just thrown away two magazines with their highly-colored side show covers after reading them and finding all but what they should contain. They are interesting to look through once, not wholesome or substantial like yours, and I prophesy will not endure the trial of a very long run.

H. N. SESSIONS,  
1528 Alta Ave., Santa Monica, Calif.

## Gets Ready for 15KW

Boston

Construction of a 15 kilowatt short wave transmitter for international broadcasting is now under way at the Shortwave & Television Corporation plant, 70 Brookline avenue.

This new short wave station has been authorized by the Federal Radio Commission and will be operated by the new Shortwave Broadcasting Corporation.

American programs are to be transmitted to South America, Europe and Asia for direct pick-up and by relaying through foreign broadcasting corporations cooperating with Shortwave Broadcasting Corporation. Experimental transmissions will begin October 1st.

# TRADE EXPECTS TELEVISION IN EMBRYO IN '32

Radio Manufacturers Association, Inc., 11 West 42nd street, New York, N. Y., issued the following:

It will be another year or more before television, in its earliest commercial form, will be available for the public, in the opinion of most radio manufacturers now actively developing television in their laboratories.

The progress and prospects of television were discussed by the Board of Directors of the Radio Manufacturers Association, according to a statement by Bond Geddes, executive vice president of the national manufacturers' organization, at a recent directors' meeting. It was the consensus, Mr. Geddes stated, that leading radio manufacturers are not planning before the fall of 1932 to present television to the public, even in its earliest stages. The initial presentation, it is expected, will be comparable to the crystal set stage of radio.

## Expect Separate Units

"While television is now available in experimental form," said Mr. Geddes, "the manufacturers and broadcasters will not be far enough along for another year to offer real entertainment values, either in broadcasting or receiving sets. Also it is virtually the unanimous opinion among manufacturers that television sets of the future will be separate units, distinct from radio receiving sets.

"By this time next year it is possible that television broadcasting will be sufficiently developed to present a limited form of entertainment to the public which will justify the offering of receiving sets to the public.

## Stock Promotion Discussed

"According to present laboratory and broadcasting experiments, in the opinion of most radio manufacturers, the initial television may be of motion pictures, with wider and more entertaining and commercial development to come much later.

"In the meantime, manufacturers of our national organization deplore unsound television stock promotion schemes or extravagant claims and publicity for the new art which, even if presented to the public in the fall of 1932, is certain to be still in an embryonic stage."

## Literature Wanted

Readers desiring radio literature from manufacturers and jobbers concerning standard parts and accessories, new products and new circuits, should send a request for publication of their name and address. Send request to Literature Editor, RADIO WORLD, 145 West 45th Street, New York, N. Y.

- Everett F. Mackay, 75 Clarendon St., Saint John, N. B., Canada.  
Wilmer Chapin, Rt. 4, Box 375, Tampa, Fla.  
Adolf Klesel, Route No. 1, Box No. 119A (Schulenburg), Texas.  
Nathan Rosengarten, 1129 Langhorn Ave., Camden, N. J.  
Wilbur E. Clemans, 735 Flanders Ave., Lima, Ohio.  
Lewis H. Cohen, Supvr. Modern Piano Radio Repair Shop, 5310 Market St., Philadelphia, Pa.  
Herbert C. Thomas, 921 Connelly St., Clovis, New Mex.  
Jack Phelan, Box 6, Dixon, Neb.  
Ralph Krum, 815 Fox St., New York City.  
Simon H. Sasser, Jr., Route 1, Box 54, Summerfield, Fla.  
K. Aiguire, c/o Zetland Garages Ltd., Battery Dept., St. Henri & St. Maurice Sts., Montreal, P. Q., Canada.  
Fred Neal, 305 McDonel St., Kinston, N. C.

# Sparkles

By Alice Remsen

**T**WENTY-TWO international programs were broadcast by the NBC during the first six months of 1931. These were included in the 149 special events broadcast, according to a mid-year record review. Royalty was represented by the Prince of Wales, the King of Siam, and Prince and Princess Takamatsu of Japan. His Holiness, Pope Pius XI has been heard twice. William Burke (Skeets) Miller, director of these special events broadcasts, deserves a whole lot of credit for the way in which he handled the details, which needless to say, were many.

\* \* \*

**Cliff Hammons**, the clever chap who broadcasts his "One Man Show" over WOR every Saturday night at 9.45, missed a broadcast on Aug. 15 for the first time in a year and a half. It was not his fault, however, and I'm sure the sympathy of his many "fan" friends will be extended to him when they learn the reason. His little five-year-old son was suddenly stricken with the dread infantile paralysis and the heartbroken father had taken the child to the hospital that very evening. Mr. Hammons will be back on the air as usual next Saturday evening to continue the adventures of his colored friends and don't forget, he plays all the parts himself, and writes his own script, too. Some day we hope to run his biography and tell you how he came to originate those funny characters.

\* \* \*

**Beginning October 9th**, the Radio Guild will be heard each Friday afternoon at 4:15. The programs will be under the direction of Vernon Radcliff. Shakespeare, Ibsen, Shaw and Barrie will be represented. A nation wide network will be served, the New York outlet being WJZ.

\* \* \*

**Radio's Oldest Program Series**, the A. & P. Gypsies, under the direction of Harry Horlick, will undergo a radical change the first week in September. The weekly hour of eight uninterrupted years on the air will be split into two periods. A dance orchestra will be heard over WJZ at 10 p.m. Thursdays. The Monday night program of light concert music will continue with Veronica Wiggins as soloist, 9 p.m. Both programs will run for half an hour and Frank Parker will solo on each program.

\* \* \*

**William S. Paley**, President of the Columbia Broadcasting System, signed Richard Tauber, after hearing him in London this summer. Mr. Tauber is a German tenor, now singing with great success in "Land o' Smiles," a London production. He will be over here in the Fall for radio and concert appearances.

\* \* \*

**Have heard of authors** keeping pencil and paper beside the bed at night in case of sudden inspiration, but Little Jack Little is the first person we've heard of to keep a bedside piano. He dreams a song and then hops out of bed and plays it.

\* \* \*

**George Shackley** appears at WOR these days looking like a florist's display. His arms are always full of choice blooms, culled from his estate in West Milford, New Jersey. He takes prizes for his fine orchids and phlox. George is prodigal with his flowers, giving much pleasure to his friends in the studios and elsewhere.

## BIOGRAPHICAL BREVITIES

### The Moonbeam Trio

The Moonbeam Trio was organized by George Shackley in September of 1929. It consists of Verna Osborne, soprano; Annette Simpson, soprano; and Veronica Wiggins, contralto.

Miss Osborne has been with the trio for a year and a half. She won first place in the Atwater Kent contest for 1929. She comes naturally by her musical talent, as her ancestors on both sides have been musicians for generations. As a child her voice was alto, but is now a soprano of the highest range. She appeared in Town Hall last spring, as soloist for the New York Singers Club, has sung with various symphony orchestras and has made numerous appearances on the concert stage. She has done stage work, too, particularly in "The Student Prince," and also is soprano soloist with WOR's Choir Invisible. Her chief interest is music, but her ambition is to become an air pilot, like her brother.

Annette Simpson, middle voice of the trio, was not yet four years old when her mother found her at the piano crying, because she could not manipulate her thumb properly. This was in Emporia, Kansas, where Annette was born. While still a little girl her family moved to Chicago, where she won a scholarship which enabled her to go to college in Ottawa, Kansas, and upon her graduation there she spent a year of graduate study, also on a scholarship, at the University of Chicago. She was one of three girls selected by the Government to work on codes in foreign languages, which work brought her to New York. She continued her piano work, playing accompaniments for singers and violinists. She earned piano lessons by secretarial work and she earned singing lessons in exchange for accompanying her teacher's other pupils. Soon she was singing in church choirs and entertaining at clubs and dinners, and still is greatly in demand for club work. She has brown hair, and a charming smile which shows a perfect set of teeth and lights up a rather serious face. She has sung in a Hebrew Temple in both Hebrew and English. She is not a mezzo-soprano, even though she is the middle voice of the trio; in fact, she has a pure lyric soprano of fine range and quality. She is unmarried and has been with WOR for two years.

Veronica Wiggins, the contralto of the Moonbeam Trio and the member who has been with it from its inception, was formerly a student at the Montclair (N. J.) High School. An executive of WOR heard her sing, persuaded her to give an audition and she has been with the station ever since and one of its most popular artists. She is the special pride of New Jersey. Veronica, in spite of her youth, began her radio work when radio was young and grew up with the industry. At rehearsals she is very businesslike and unemotional. She is a tall girl with broad shoulders and the deep chest of a true singer. Her rich contralto tones are the joy of her audience. She produces them in an effortless manner. There is never any straining for effect. Veronica sings as if she just couldn't help it. She has no ambition for opera but confesses that she would love to be a concert singer. Besides being of the Moonbeam Trio, Veronica is also a member of the Choir

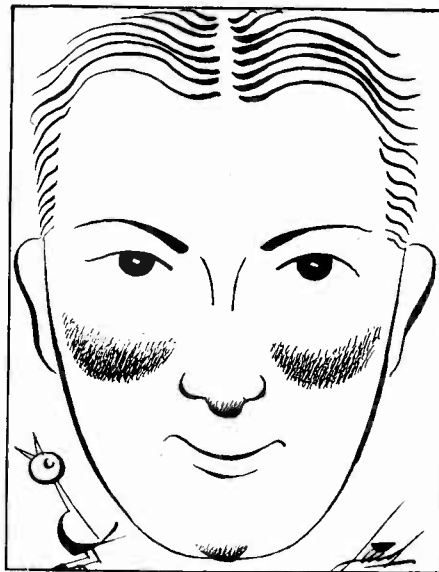

The Barbasol Man, Columbia Broadcasting System.

Invisible and soloist with the Gypsies with NBC.

If you have never listened to these girls sing, you have missed a treat. Tune in any evening except Saturday, at 10:30 on Station WOR, and you will hear an exceptional program. George Shackley is justly proud of this organization.

\* \* \*

### SUNDRY SUGGESTIONS FOR WEEK COMMENCING AUGUST 30th

Toscha Seidel.....	WABC
3 p.m.—August 30th	
Eddy Brown String Quartet.....	WOR
7:45 p.m.—August 30th	
Lew White, Organist.....	WJZ
11:30 p.m.—August 30th	
Vaughan De Leath, Contralto....	WEAF
11:00 p.m.—August 31st	
David Guion, Hearing America....	WOR
8:00 p.m.—September 1st	
Footlight Echoes.....	WOR
9:15 p.m.—September 2nd	
Carlo Le Mar.....	WJZ
10:45 p.m.—September 2nd	
Welcome Lewis.....	WABC
9:15 p.m.—September 3rd	
Willard Robison.....	WEAF
9:30 p.m.—September 3rd	
Jack Arthur, the Happy Vagabond..	WOR
11:15 a.m.—September 4th	
Jessica Dragonette and Cavaliers..	WEAF
8:00 p.m.—September 4th	
Whispering Jack Smith.....	WABC
6:30 p.m.—September 5th	
Alice Remsen.....	WOR
10:00 p.m.—September 5th	

## \$10,000 Offered for New Orchestral Works

A total of \$10,000 in awards will be made to the five American composers producing the best original orchestral works by Thursday, December 31st, under arrangements completed by the National Broadcasting Company and Deems Taylor.

"Anybody who writes a serious piece of music today does so as a luxury," said Taylor.

Announcement of decision on the five best manuscripts will be made and the compositions will be played by an NBC symphony orchestra on Sunday, February 21st, 1932. The composition receiving first award will be offered over combined nationwide NBC networks on February 22d, 1932—coincident with international recognition and celebration of the two-hundredth anniversary of the birth of George Washington.

First award is \$5,000; second award, \$2,500; third award, \$1,250; fourth award, \$750; fifth award, \$500.

Details may be obtained by prospective entrants by addressing NBC Orchestral Awards, 711 Fifth Avenue, New York, N. Y.

**SYNCHRONOUS MOTOR, \$4.25**



For use on 60-cycle AC line. 12-inch turntable included. 80 revolutions per minute. The speed is self-regulated. This compact synchronous motor may be used with a phonograph pickup to play records. Cat. SYN-M @ \$4.25.

DIRECT RADIO CO., 143 W. 45th St., New York, N. Y.

**Never Before At These Prices!**

**SPEAKERS**

Farrand inductor dynamic for pentode tubes, chassis (no cabinet), for direct connection in plate circuit of single output tube, or for connection to secondary of an output transformer where push-pull pentodes are used. 9 inch outside diameter. Order Cat. 9-R.....@ \$7.00  
 Farrand regular dynamic, chassis (no cabinet), with built-in rectifier, for AC operations. 9 inch outside diameter. Order Cat. F-DNS.....@ \$7.00  
 Erla regular dynamic, chassis (no cabinet), for 6-volt storage battery operation, Westinghouse rectifier. Order Cat. ER-DYN.....@ \$8.50  
 Ansonia magnetic speaker in Gothic cabinet of genuine walnut. Order Cat. AN-G.....@ \$3.50  
 Ansonia magnetic speaker, in square cabinet, genuine walnut. Order Cat. AN-SQ.....@ \$3.00  
 Temple dynamic speaker, in carved wood cabinet, with impedance matching device built in; AC operation; rectifier built in. Order Cat. TEM-DYN.....@ \$10.23

**BOOKS**

Gernsback's Cyclopedia. Cat. GBC.....@ \$1.00  
 Rider's Trouble Shooter's Manual, First Edition. Cat. TSM-FST.....@ \$1.40  
 Supplement No. 1 to Rider's Manual. (115 diagrams.) Cat. R-SUP.....@ \$ .60  
 Drake's Encyclopedia. Cat. DRA.....@ 3.60

**COILS**

Three-circuit tuner coil for .0005 mfd., with silver-plated wire and space-wound winding on threaded bakelite form. Cat. SPW-T.....@ \$1.10  
 Radio frequency coil to match above, same construction. Cat. SPW-RF.....@ .65

**RESISTORS**

25,000 ohm potentiometer. Cat. POT-25.....@ \$ .88  
 5,000 ohm rheostat with AC switch attached. Cat. RH-5S.....@ .52  
 Adjustable voltage divider, with sliders; six different voltages besides extremes; total is 10,000 ohms. Order Cat. VVD.....@ 1.00  
 Fixed voltage divider, total 17,100 ohms, affording twenty different voltages, including all bias voltages; for 245, 247 and similar circuits; 50 watts rating. Order Cat. MTVD.....@ 1.95  
 Carborundum grid leaks, 5 meg. Cat. CAR-5.....@ .10  
 30 ohm filament resistor, 1 ampere capacity. Cat. FR-30.....@ .10  
 6.5 ohm filament resistor, 1 ampere capacity. Cat. FR-65.....@ .10  
 2250 ohm 25 watt resistor (Ward Leonard). Cat. WL-2.....@ .10

**CONDENSERS**

.0025 mfd. grid condenser with clips. Cat. GRC.....@ .12  
 Shielded .0005 mfd. Scovill condenser. Cat. SCO-5.....@ .89  
 .00035 mfd. Scovill non-shielded condenser. Cat. SCO-3.....@ .29  
 .00035 mfd. two-gang Scovill unshielded. Cat. SCO-2G.....@ .49  
 Heath short-wave condenser .00014 mfd. Cat. HE-14.....@ .44  
 Erla short-wave condenser, .0001 mfd. Cat. ER-1.....@ .41  
 Condenser block (dry) for 300-volt B supply; 8 mfd., 6 mfd., two 1 mfd. and one .5 mfd. in one case. Cat. FL-BL.....@ 3.00  
 Hammarlund double drum dial. Cat. H-DDD.....@ 1.50  
 Marco vernier dial, disc type. Cat. MAR-D.....@ .50  
 KK vernier dial. Cat. KKVDS.....@ .44  
 4-inch plain bakelite dial (not vernier). Cat. PL-D.....@ .12

**OTHER PARTS**

Phonograph pickup, Allen Hough. Cat. PHPU.....@ \$ .75  
 Wave trap. Cat. WT.....@ .90  
 Atwater Kent horn unit. Cat. AKHU.....@ 2.75  
 Westinghouse rectifier, for dynamic speaker. Cat. WESRC.....@ 1.50  
 Follow-through AC switch in moulded case. Cat. FTSW.....@ .20  
 Aluminum tube shield. Cat. ALTS.....@ .14  
 Binding posts. Cat. BNDP.....@ .05

**RELIABLE RADIO COMPANY**

143 West 45th Street  
 New York, N. Y.

**Send \$8.26! Get This Tester!**

HERE is your opportunity to get immediate delivery of the Jiffy Tester at \$8.26 remittance with order, balance of \$3.50 payable in one year. Your credit is good with us. This Tester will read plate current, plate voltage and filament voltage simultaneously, when plug is put into any set socket and tube in the Tester.

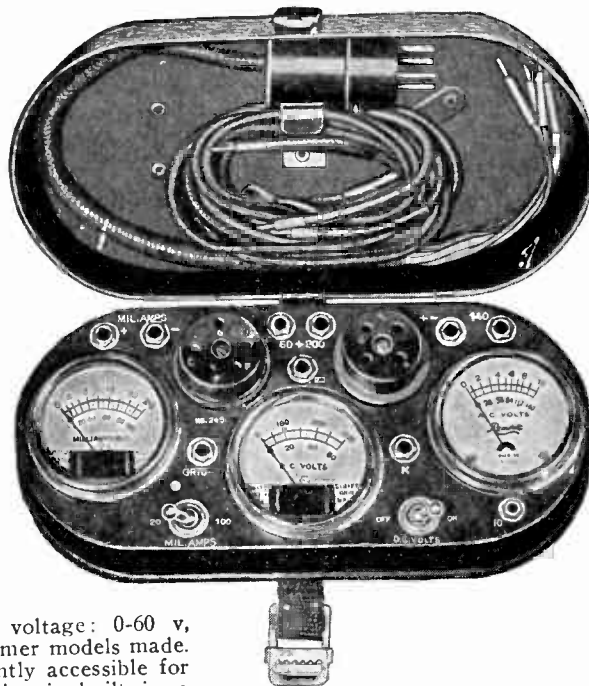

Jiffy Tester, Model JT-N, consists of three double-reading meters, with cable plug, 4-prong adapter test cords and screen grid cable. The ranges are filament, heater or other AC or DC 0-10 v, 0-140 v; plate current: 0-20, 0-100 ma; plate voltage: 0-60 v, 0-300 v. It makes all tests former models made. Each meter is also independently accessible for each range. The entire device is built in a chromium-plated case with chromium-plated slip-cover. Instruction sheet will be found inside. Order Cat. JT-N @ \$11.76; \$8.26 down.

DIRECT RADIO CO.  
 143 W. 45th St., N. Y. C.

**Tubes at 30¢ Each**

Four for \$1.00	
280	200A
226	245
171	

Sold on basis of remittance with order. We will pay the postage.

RELIABLE RADIO CO.  
 143 West 45th Street New York, N. Y.

**NATIONAL DRUM DIAL**



National Velvet Vernier drum dial, type H, for 1/4" shaft. An automatic spring take-up assures positive drive at all times. Numbers are projected on a ground glass. Rainbow wheel changes colors in tuning. Modernistic es-cutcheon. Order Cat. ND-H @ \$3.13.

GUARANTY RADIO GOODS CO.  
 143 West 45th Street, New York, N. Y.

**SOLDERING IRON FREE!**



Works on 110-120 volts, AC or DC; power, 50 watts. A serviceable iron, with copper tip, 5 ft. cable and male plug. Send \$1.50 for 13 weeks' subscription for Radio World and get these free! Please state if you are renewing existing subscription.

RADIO WORLD  
 145 West 45th St. N. Y. City

**RADIO WORLD and "RADIO NEWS"**

BOTH FOR ONE YEAR \$7.00

You can obtain the two leading radio technical magazines that cater to experimenters, service men and students, the first and only national radio weekly and the leading monthly, for one year each, at a saving of \$1.50. The regular mail subscription rate for Radio World for one year, a new and fascinating copy each week for 52 weeks, is \$6.00. Send in \$1.00 extra, get "Radio News" also for a year—a new issue each month for twelve months Total, 64 issues for \$7.00.

RADIO WORLD, 145 West 45th Street, New York, N. Y.

**NEW DRAKE'S ENCYCLOPEDIA**  
 1,680 Alphabetical Headings from A-battery to Zero Beat; 1,025 Illustrations, 920 Pages, 240 Combinations for Receiver Layouts. Price, \$6.00. Radio World, 145 W. 45th St., N. Y. C

**NEW BOOKS**

"EXPERIMENTAL RADIO ENGINEERING," by Prof. John H. Morecroft, of the Department of Electrical Engineering, Columbia University. A companion book to the author's "Principles of Radio Communication," but in itself a text on practical radio measurements. Cloth bound, 345 pages, 6 x 9, 250 figures.....\$3.50

"THE RADIO HANDBOOK," by James A. Moyer and John F. Wostrel, both of the Massachusetts Department of Education. Meets the need for a complete digest of authoritative radio data, both theoretical and practical. Flexible binding, 886 pages, 650 illustrations.....\$5.00

"RADIO FREQUENCY MEASUREMENTS," by E. B. Moulin, M.A., A.M., E.E., M. I. Rad. Eng. Reader of Engineering Science in the University of Oxford. Second Edition, entirely reset and greatly enlarged. For advanced students with mathematical foundations. Cloth, 487 pages and 289 illustrations.....\$12.50

"FOUNDATIONS OF RADIO," by Rudolph L. Duncan. A treatise for the beginner, setting forth clearly and carefully the electrical phenomena associated with radio. Just the book to give you a firm grip on the subject.....\$2.50

Remit with order. We pay transportation. Ten-day money-back guaranty on all books.

Radio World, 145 45th St., New York, N. Y.

**Large Temple Dynamic**

Dynamic speaker, AC 110 Volts, 50 to 60 cycles, housed in table cabinet made of walnut, with carved grille. Output transformer and dry rectifier built in, also a hum eliminating adjuster and a variable impedance matcher. Plugged AC cable and tipped speaker cords are attached to dynamic. Outside cabinet dimensions: Height 14", width 11, depth 7 1/2". Speaker diameter 9". Price, \$11.50 net.

**Guaranty Radio Goods Company**  
Dept. A, 143 W. 45th St., N. Y. C.

**THREE-IN-ONE  
TESTER FREE!**

EVERYBODY who does any radio work whatsoever, whether for fun or for pay or for both, needs a continuity tester, so he can discover opens or shorts when testing.

A mere continuity tester is all right, but—Often it is desired to determine the resistance value of a unit, to determine if it is correct, or to measure a low voltage, and then a continuity tester that is also a direct-reading ohmmeter and a DC voltmeter comes in triply handy.

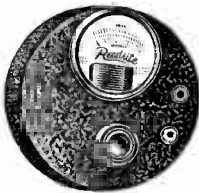

So here is the combination of all three: A 0-4 1/2-volt DC voltmeter, a 0-10,000-ohm ohmmeter and a continuity tester. A rheostat is built in for correct zero resistance adjustment or maximum voltage adjustment. The unit contains a three-cell flashlight battery. Supplied with two 5-foot-long wire leads with tip plugs. Case is 4-inch diameter baked enamel. Weight, 1 lb. Sent free with an order for one year's subscription for RADIO WORLD (52 weeks) at the regular rate of \$6. Order Cat. PR-500.

Radio World, 145 W. 45th Street, New York, N. Y.  
Enclosed please find \$6 for one year's subscription for Radio World (one copy a week, 52 issues). Send Cat. PR-500 as premium.

Name .....

Address .....

City..... State.....

**8 5 3 PAGES,  
1,800 DIAGRAMS  
IN RIDER'S NEW  
6-LB. MANUAL**

THE most complete service man's manual is "The Perpetual Trouble Shooter's Manual," by John F. Rider, published April, 1931, and full of real information. Wiring diagrams of ALL popular commercial receivers and kit sets from 1922 to 1931, inclusive. Also contains a course in trouble shooting. Loose leaf pages, 8 1/2 x 11", bound. 853 pages; index and advertisements on additional pages. Order Cat. RM-31, and remit \$4.50. We will then pay postage. (Shipping weight, 6 lbs.) Ten-day money-back guarantee.

**RADIO WORLD**  
145 West 45th Street, New York, N. Y.

**115 DIAGRAMS  
FREE!**

115 Circuit Diagrams of Commercial Receivers and Power Supplies supplementing the diagrams in John F. Rider's "Trouble Shooter's Manual." These schematic diagrams of factory-made receivers, giving the manufacturer's name and model number on each diagram, include the MOST IMPORTANT SCREEN GRID RECEIVERS.

The 115 diagrams, each in black and white, on sheets 8 1/2 x 11 inches, punched with three standard holes for loose-leaf binding, constitute a supplement that must be obtained by all possessors of "Trouble Shooter's Manual," to make the manual complete. We guarantee no duplication of the diagrams that appear in the "Manual." Circuits include Bosch 54 D. C. screen grid; Bakelite Model F, Crosley 20, 21, 22 screen grid; Eveready series 50 screen grid; Eria 224 A. C. screen grid; Peerless Electrostatic series; Philco 76 screen grid.

Subscribe for Radio World for 3 months at the regular subscription rate of \$1.50, and have these diagrams delivered to you FREE!

Present subscribers may take advantage of this offer. Please put a cross here  to expedite extending your expiration date.

Radio World, 145 West 45th St., N. Y. C.

**Fixed Condensers**

Dubilier Micon fixed condensers, type 642, are available at following capacities and prices:

.0001 mfd. ....	10c	.0005	.....	20c
.00025 mfd. ....	10c	.00025 with slips.	.....	20c
.0005 mfd. ....	10c	All are guaranteed	.....	
.00035 mfd. ....	12c	electrically perfect and	.....	
.001	.....	money back if not	.....	
.0015	.....	satisfied within five	.....	
.002	.....	days.	.....	

**GUARANTY RADIO GOODS CO.**  
143 West 45th St., New York, N. Y.

**BARGAINS**

**"A" ELIMINATOR PARTS**

Choke coil, to filter out the hum. Wound with No. 16 wire on secondary. Husky choke. Only one needed. Will pass 3 amperes. In shielded case. Cat. AECH @ .....\$5.50  
Westinghouse Rectox metal disc rectifier, to pass 2 amperes, or connect rectifiers in parallel to pass 4 amperes; mounting brackets. Cat. WRX @ .....\$1.95  
Jefferson transformer, 110 v. 50-60 cycle primary; 12 volts, no load; 9 volts when used full load on Rectox rectifier; DC voltage at full load, 7 volts. Cat. J-12V @ .....99c  
Dry electrolytic condenser, 1,500 mfd. (two required). Cat. DRL @ .....\$3.25  
Steel cabinet, 12" long x 9" front to back x 9" high; cutout for bakelite binding post strip. Cat. SCAB @ .....89c

**TESTOLIGHT**

Neon lamp in bakelite housing with two test prods. Tells whether voltage is AC or DC, and if DC which side is negative. Finds shorts and opens. Full directions. Cat. TSTL @ .....99c

**CABLE AND PLUG**

Five-lead cable with 5-prong plug attached that fits into UY socket. Useful as a connector of set voltages or for short-wave adapters. Cat. CPG @ .....62c

**HOOKUP WIRE**

10-strand genuine copper wire (not steel or alloys), with rubber insulation above which is ornamental fabric insulation. Best hookup wire for sets. Insulation good for 1,000 volts or more. Available in five different types: blue, brown, red with black marker, blue with white marker, green. Cat. HW (specify color). 12 ft. lengths @ ..41c

**RESISTORS**

Grid leaks 5 meg., 2 meg., 1/4 meg., 1 meg., 5,000 ohms (specify which) Cat. CGL @ .....11c  
Filament ballasts: 4 ohm for one 201A, 112A, 200A, 240A, 171A; 2 ohm for two 201A, 112A, 200A, 240 or 171A, or for one 171 or 112 Mounting supplied. (Specify which.) Cat. FB @ .....11c

Wire-wound resistors: 1 ohm, 1-3/10 ohm, 6-5/10 ohms; 30 ohms; 50 ohms. (Specify which.) No mounting supplied or needed. Cat. WWR @ 16c  
30-ohm rheostat with battery switch attached. Cat. 30RH @ .....65c  
75-ohm rheostat with battery switch attached. Cat. 75RH @ .....65c  
25,000 ohm potentiometer, wire-wound; Electrad Tonatrol. Will pass 30 ma. Excellent volume control or for tone control in series with .3 mfd. condenser. Cat. ELLT @ .....99c  
Variable voltage divider; 10,000 ohms; will pass 100 ma; eight sliders and fixed terminal connections; mounting bracket. Cat. VVD @ .....\$1.49

**CONDUCTORS**

2 ampere fuse, cartridge type, for fusing AC line entering receiver; with fuse holder. Cat. 2AFH @ .....25c

**GUARANTY RADIO GOODS CO.**  
143 West 45th Street, New York, N. Y.  
(Just East of Broadway)

**Quick Action Classified Ads**  
Radio World's Speedy Medium for Enterprise and Sales  
7 cents a word—\$1.00 minimum—Cash with Order

**BENCH LEGS — STEEL ANGLES** — Shipped knock-down for work and display — \$3.00 up. Kite Hardware, Room 308, 128 East 23rd St., New York City.

**THE FORD MODEL—"A" Car and Model "AA" Truck**—Construction, Operation and Repair. By the Ford Car authority, Victor W. Page. 703 pages, 318 illustrations. Price \$2.50. Radio World, 145 W. 45th St., New York.

**SUMMER BARGAIN IN .00035 MFD.** Here is your opportunity to get a 4-gang .00035 condenser, with trimmers built-in, at only 92 cents, on basis of remittance with order. Shipping weight, 3 lbs. Include postage or condenser will be sent express collect. Direct Radio Co., 143 West 45th Street, New York, N. Y.

**NEW RADIO OFFER. PENTODE A. C.** Specialty. Agents coining money. Free details. Radio Reporter, 18 Merchandise Mart, Chicago.

**PHONOGRAPH PICK-UP** — Made by Allen-Hough. \$3.32. Guaranty Radio Goods Co., 143 W. 45th St., N. Y. C.

**"RADIO FREQUENCY MEASUREMENTS"** by E. B. Moulton. M. A., A. M. I. E., M. I. Rad. Eng. Second Edition entirely reset and greatly enlarged illustrated. 487 pages, plus 12-page index. Indispensable for radio experts and engineers. \$12.50. Radio World, 145 W. 45th St., N. Y. City.

**30 HENRY 160 MIL. CHOKES**, \$60; 2 and 3 gang condensers. \$95; filter condensers, \$35 per mfd. F. Wolf, David Street, Great Kills, S. I., N. Y.

**25,000 OHM POTENTIOMETER**, wire wound, in shield case; takes 1/4" shaft. Will stand 20 ma. easily. Excellent as a volume control. Price, 90c. Direct Radio Co., 143 West 45th Street, New York, N. Y.

**RADIO WORLD AND RADIO NEWS.** Both for one year, \$7.00. Radio World, 145 W. 45th St., N. Y. City.

**SHORT-WAVE NUMBERS OF RADIO WORLD.** Copies of Radio World from Nov. 8, 1930 to Jan. 3, 1931, covering the various short-wave angles sent on receipt of \$1.00. Radio World, 145 W. 45th St., N. Y. City.

**"RADIO TROUBLE SHOOTING,"** E. R. Haan. 328 pages, 300 illustrations, \$3. Guaranty Radio Goods Co., 143 W. 45th St., New York.

**SOUND PICTURES TROUBLE SHOOTER'S MANUAL**, by Cameron and Rider, an authority on this new science and art. Price \$7.50. Book Dept., Radio World, 145 W. 45th St., N. Y. City.

**"A B C OF TELEVISION"** by Yates—A comprehensive book on the subject that is attracting attention of radioists and scientists all over the world. \$3.00, postpaid. Radio World, 145 West 45th St., N. Y. City.

**"HANDBOOK OF REFRIGERATING ENGINEERING,"** by Woolrich—Of great use to everybody dealing in refrigerators. \$4. Book Dept., Radio World, 145 W. 45th St., N. Y. City.

**TELEVISION DISC**—12-inch aluminum scanning disc. Mention style and number of holes. 1/4 or 3/8 mounting. \$2.00. Cash with order. LeRoy Jones, 110 22nd Ave., Melrose Park, Ill.

**BALKITE A-5 RECEIVER.** eight-tube, three stages of Neutrodyne RF and two stages audio with push-pull output. Good distance-getter and very sensitive. Has post for external B voltage for short-wave converters. Brand new in factory case. Berkey-Gay walnut table model cabinet. Price \$35 (less tubes). Direct Radio Co., 143 West 45th St., New York.

**SITUATIONS WANTED**

**OPERATOR**—Commercial Operators' License. Age 26. Two years Broadcast operating. Both codes. Graduate Dodge Radio Institute and National Radio Institute; also member of Institute of Radio Engineers. Desires position, anything considered. H. D. Rissler, Hughesville, Missouri.

**OPERATOR**—U. S. Gov't Radio License. Both Codes. Wire, telegraph and telephone testboard experience. Age, thirty. Position wanted. Factory work considered. Berry, 48 Post Ave., New York City.